

Bonfiglioli **Riduttori**

BMD

Permanent Magnet AC
Synchronous Motors

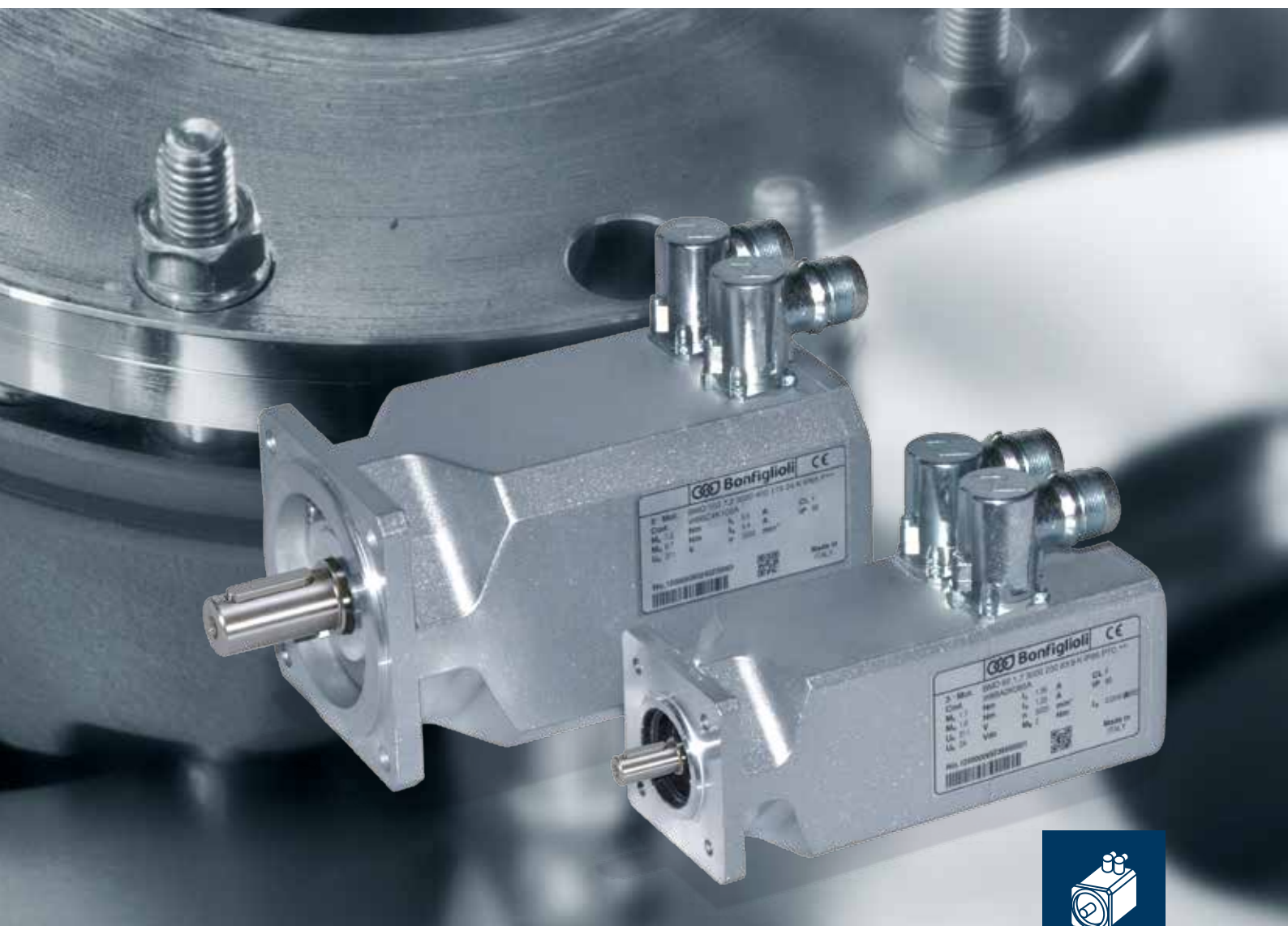

PRODUCT

 **Bonfiglioli**
Forever Forward

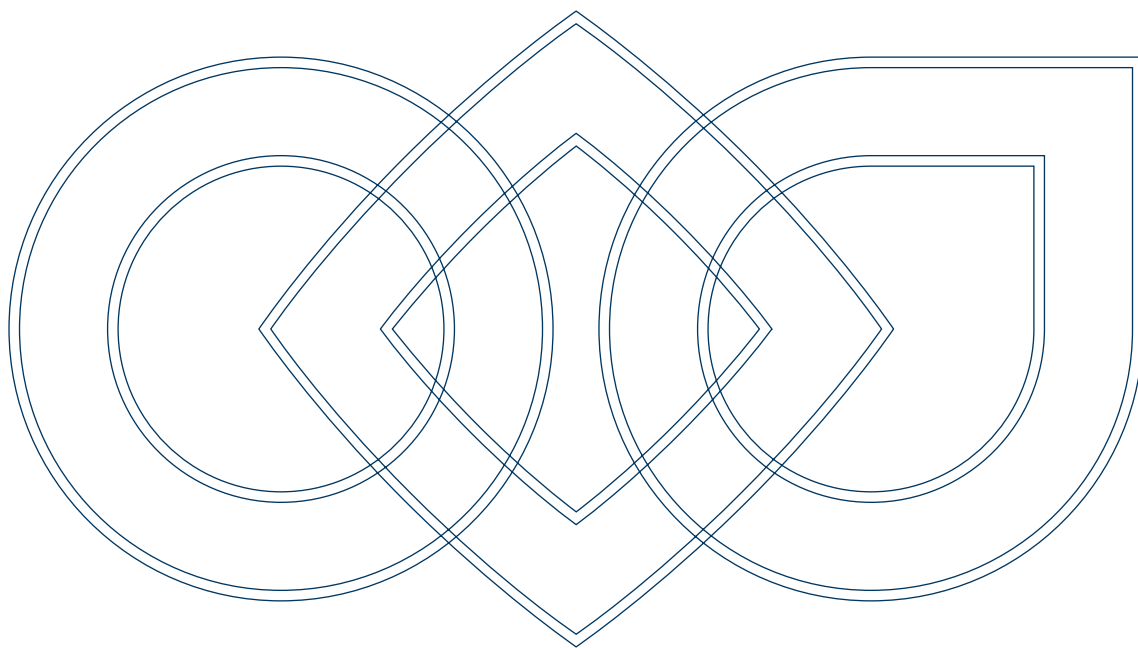

Focus on our synchronous servomotors

These permanent magnet AC synchronous servomotors are ideal for any type of automatic machinery in particular applications with high dynamic requirements. They are particularly suited to typical applications in plastic and metal machining, packaging, food and beverage processing, winding and textile industries.

They are manufactured using the "salient pole" technology. The dimensions of the motor are drastically reduced, with considerable advantages in terms of torque density, overall dimensions and dynamic performance.

Thanks to the high quality and of the neodymium iron boron rare-earth magnets performance are maximized in terms of very high accelerations and withstand high overloads without risk of demagnetization of the magnets.

The motors are available in six frames covering a stall torque range between 0.85 ÷ 45 Nm.

These brushless sinusoidal motors are designed for a three phase power supply, 230Vac and 400Vac.

BMD motor series are manufactured using class F insulation materials, cooling method IC410 (free ventilation).

Since each servomotor has a protective temperature sensor (PTC or KTY) integrated in the motor windings, operating temperature is constantly

acquired and monitored by the drive to prevent all risk of damage to the motor irrespective of operating conditions.

An optional electromechanical holding brake is available for all models. Brake operation is controlled entirely by the frequency inverter.

The following feedback devices are available:

- Resolver with excitation frequency 8 and 10 kHz
- Single turn and Multi-turn: Hiperface and EnDAT protocols supported
- Sensorless versions (specific control algorithms with sensorless servo drive are required).

BMD Series servomotors is controlled in speed and/or torque by a suitable electronic servo drive. The servo drive therefore constitutes an integral part of the actuator and requires perfect synchronization with it in order to achieve optimum performance.

The combination of BMD servomotors with frequency inverters from Bonfiglioli inverters ensures the perfect control of the motor in order to optimise the performance according to the machine requirements.

BMD motors are optionally available with an external additional flywheel mass to face the machine inertia.

BMD series are available with degree of protection IP65 (standard) and IP67 (optional).



Focus on our sensorless drives

Bonfiglioli Agile drive matches with Permanent Magnet AC synchronous motor technology by featuring a sensorless control of these motors.

Bonfiglioli Agile drives use efficient algorithms to estimate the instantaneous angular position of the motor shaft from measurements of the current absorbed by the motor. Therefore, Bonfiglioli Agile drives can control brushless servomotors without the need of any feedback sensors.

Thanks to our new development software, we can reach high torque and speed control accuracy.

Key benefits for our customers:

- Energy savings and compactness
- Wide constant torque at high speed range
- Wiring reduction
- Cost saving for high dynamic sensorless application

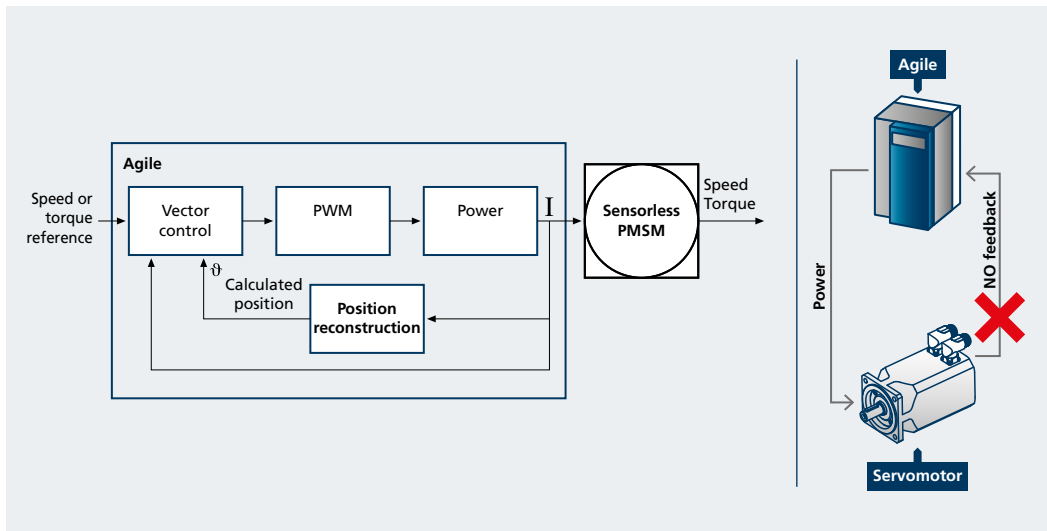

SEN P1/P1N
8-pin power connector

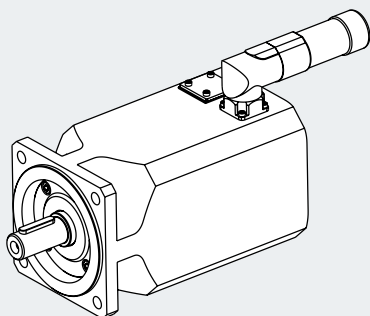

SEN P2
1-meter power cable

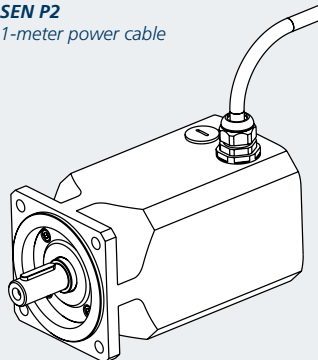

Standards and directives

BMD motors are manufactured in accordance with applicable standards and Directive listed in the following tables.

Standard

IEC 60034-1, EN 60034-1

Rotating electrical machines
Part 1: Rating and performance

IEC 60034-5, EN 60034-5

Rotating electrical machines
Part 5: Degrees of protection provided by the integral design of rotating electrical machines (IP code) - Classification

IEC 60034-6, EN 60034-6

Rotating electrical machines
Part 6: Methods of cooling (IC Code)

IEC 60034-8, EN 60034-8

Rotating electrical machines
Part 8: Terminal markings and direction of rotation

IEC 60034-14, IEC 60034-14

Rotating electrical machines
Part 14: Mechanical vibration - Measurement, evaluation and limits of vibration severity

IEC 60072-1

Dimensions and output series for rotating electrical machines - Part 1

IEC TS 60034-25

Rotating electrical machines
Part 25: Guidance for the design and performance of a.c. motors specifically designed for converter supply

Directives

Low Voltage Directive: 2006/95/EC

The BMD servomotors series comply with UL/CSA standards for the North American market (UL file number E358266).

UL 1004-1

Rotating Electrical Machines
General Requirements

UL 1004-6

Servo and Stepper Motors

CSA C22.2 No. 100

Motors and Generators

Symbols and units of measure

Symbol	U.m.	Description
n_n	[min ⁻¹]	Rated speed
M_n	[Nm]	Rated torque
P_n	[kW]	Rated power
I_n	[A]	Rated current
M_0	[Nm]	Stall torque
I_0	[A]	Stall current
M_{max}	[Nm]	Max torque
I_{max}	[A]	Max current
K_T	[Nm/A]	Torque constant
K_c	[V/1000min ⁻¹]	Back EMF constant
R_{pp}	[Ω]	Stator phase-phase resistance
L_{pp}	[mH]	Stator phase-phase inductance
τ_{el}	[ms]	Electric time constant
τ_{therm}	[min]	Thermal time constant
J_M	[kgm ² x 10 ⁻⁴]	Motor moment of inertia
m_M	[kg]	Motor mass without brake
J_b	[kgm ² x 10 ⁻⁴]	Brake moment of inertia
m_b	[kg]	Brake mass
M_b	[Nm]	Brake torque
P_b	[W]	Brake electrical power at 20°C
V_b	[V]	Brake DC voltage
I_b	[A]	Brake current
m_{MB}	[kg]	Motor mass with brake
t_1	[ms]	Brake engaging time
t_2	[ms]	Brake release time

Bonfiglioli permanent magnet synchronous motors range

The Bonfiglioli permanent magnet synchronous motors are available in six sizes with stall torque comprises between 0.85 ÷ 45 Nm.

BMD servomotor
Bonfiglioli Permanent Magnet High Density Product Line Up

- Competitive technology
- Low inertia
- Highest dynamics;
- High torque density;
- Precision;
- Compact design
- Compatibility with gears & inverters

BMD series
Permanent Magnet AC Motors

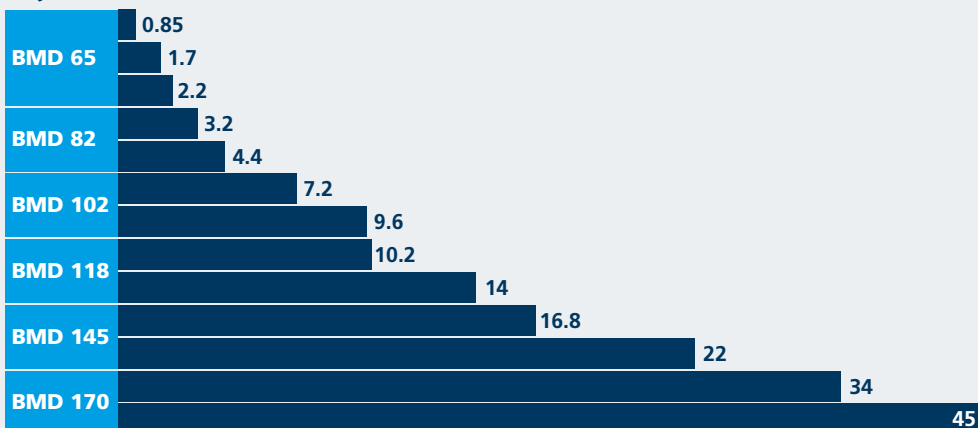
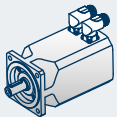

Product designation of Bonfiglioli permanent magnet synchronous motors

BMD servo motors are technically identified by their designation. This consists of a succession of alphanumeric characters, whose positions and values conform to precise rules and define the characteristics of the product.

The complete designation provides a unique identification of the exact servomotor configuration.

The designation is made up of two main parts, containing fields for:

- BASIC variants
- OPTIONAL variants

Both the BASIC variant and OPTIONAL variant sections of the designation are divided into fields, each of which defines a particular design feature of the motor.

All basic variant and optional variant fields can assume only one value at a time. These values are selected from a limited set of pre-defined values for each field in the designation.

Is mandatory to select one of the possible choices in all variants fields. The variant can be missed only where a blank is a possible choice.

Housing of BMD servomotors is painted RAL 9005, black.

A brief overview of the available combinations of the basic variants such as motor size, motor stall torque, nominal voltage and nominal speed can be found in the following table.

		BMD 65			BMD 82			BMD 102		BMD 118		BMD 145		BMD 170	
		0.85 Nm	1.7 Nm	2.2 Nm	3.2 Nm	4.4 Nm	7.2 Nm	9.6 Nm	10.2 Nm	14 Nm	16.8 Nm	22 Nm	34 Nm	45 Nm	
400 V	1600 rpm		X	X	X	X	X	X	X	X	X	X	X	X	
	3000 rpm	X	X	X	X	X	X	X	X	X	X	X	X	X	
	4500 rpm	X	X	X	X	X	X	X	X	X	X	X			
	5500 rpm	X	X	X	X	X	X	X	X	X	X	X			
	6000 rpm	X	X	X	X	X	X	X	X	X	X				
230 V	1600 rpm	X	X	X	X	X	X	X	X	X	X	X	X		
	3000 rpm	X	X	X	X	X	X	X	X	X	X	X	X		
	4500 rpm	X	X	X	X	X	X	X	X						
	5500 rpm	X	X	X	X	X	X	X	X						
	6000 rpm	X	X	X	X	X	X	X							

Product designation of Bonfiglioli servomotors

Brushless Motors designation

Basic Variants

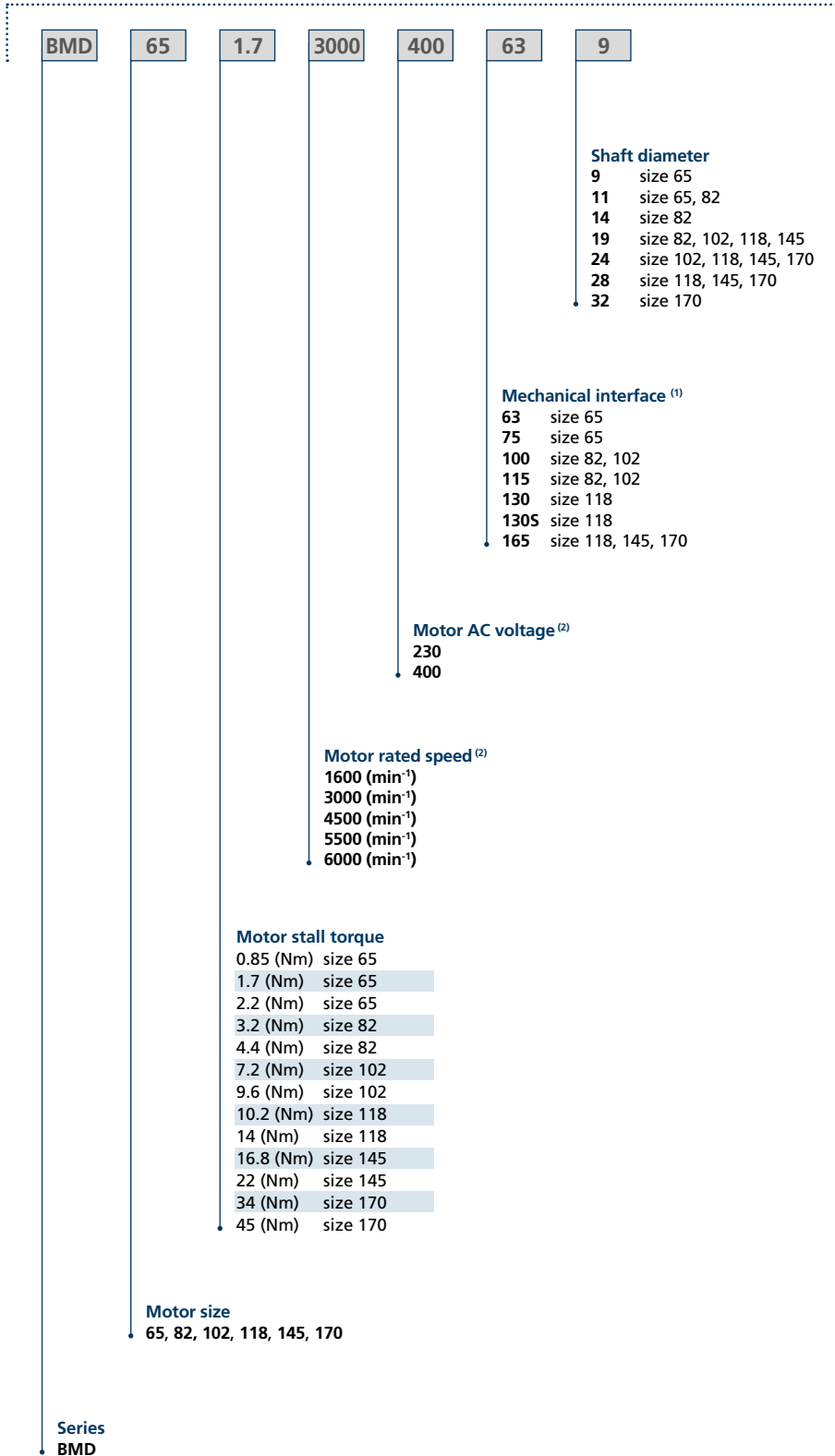

Basic Variants

Optional Variants

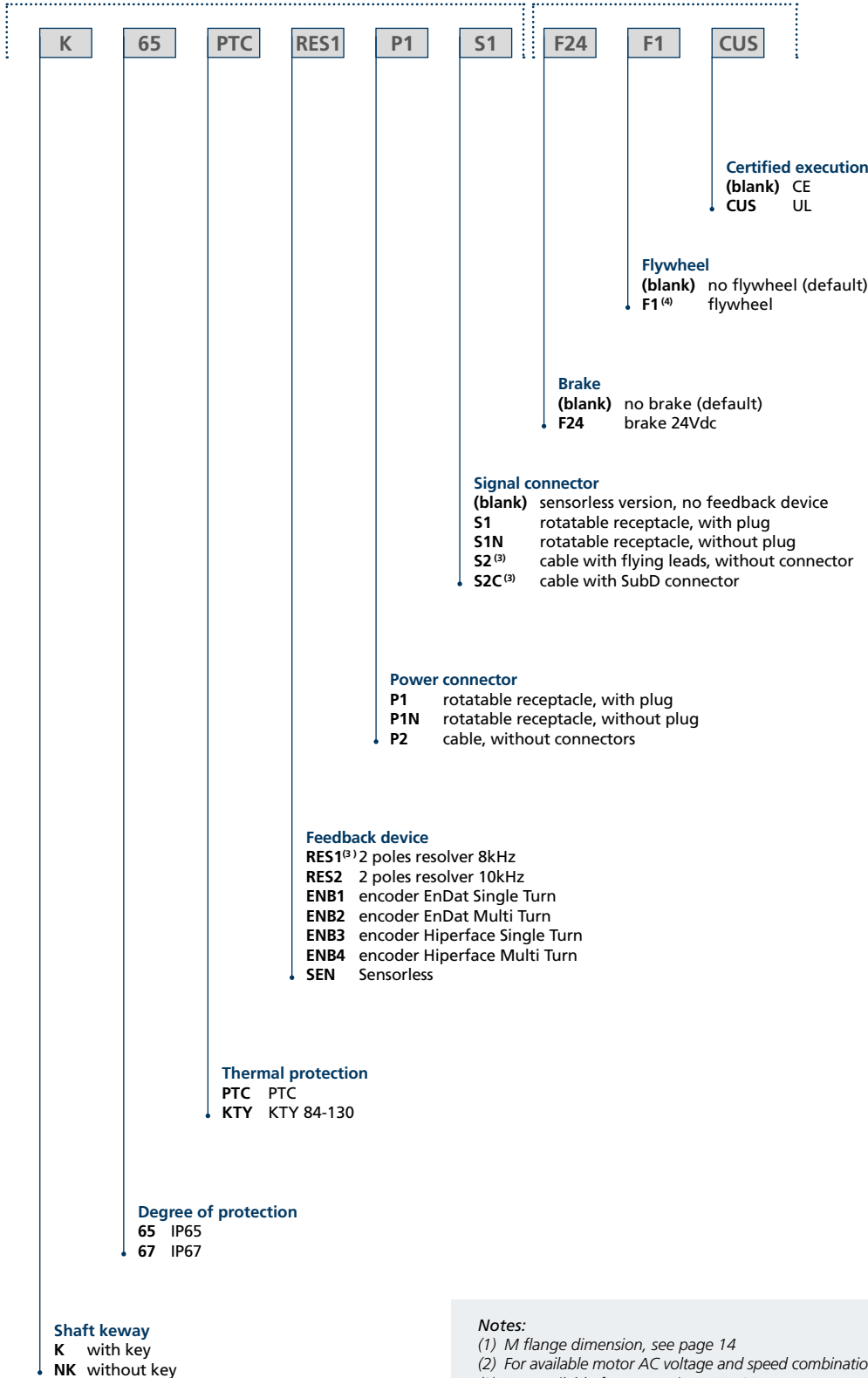

Mechanical interface

Concerning BMD servomotors, fixing dimensions for coupling motor with other transmission components (gearboxes, joints, ...) is named Mechanical Interface. Therefore the Mechanical Interface is a part of the motor and includes both flange and shaft

univocally defined by its geometrical dimensions. The flanges and the shafts of BMD are described by fixed geometrics according to standard IEC 60072-1.

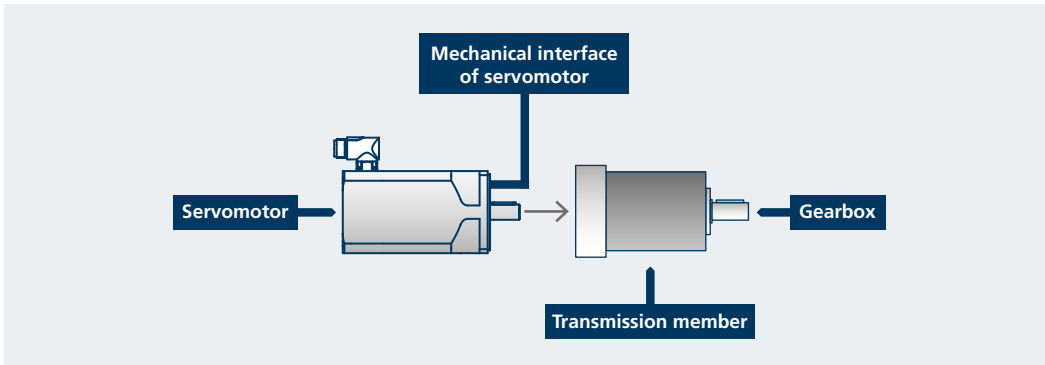

Mechanical interface: connection flange + transmission shaft.

According to IEC 60072-1, the interface geometry is defined by quantities D, E, P, M, N, S published in the following drawing whose numerical values (mm) depend on motor size.

The basic mechanical interface of BMD servomotors is defined by the dimensional sketch:

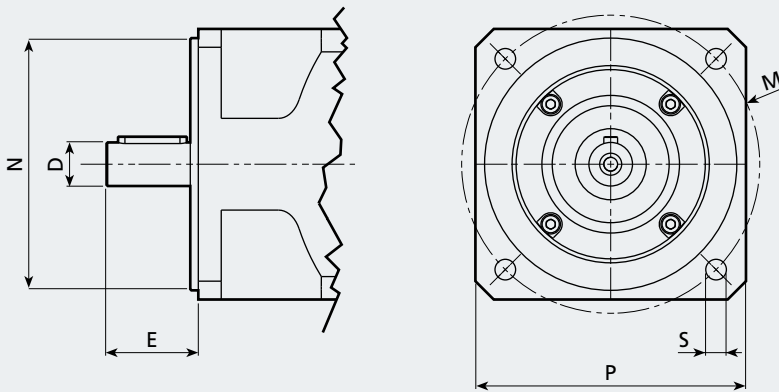

Basic Mechanical Interface

		Servomotors											
		BMD65		BMD82		BMD102		BMD118			BMD145		BMD170
Shaft diameter x shaft length	DxE [mm]	9x20 11x23		11x23 14x30 19x40		19x40 24x50		19x40 24x50 28x60			19x40 24x50 28x60		24x50 28x60 32x60
Flange square	P [mm]	65	65	82	100	102	102	118	118	145	145	170	
Flange pitch holes diameter	M [mm]	63	75	100	115	100	115	130 ⁽¹⁾	130	165	165	165	
Diameter of the spigot	N [mm]	40	60	80	95	80	95	95	110	130	130	130	
Fixing holes diameters	S [mm]	5.5	6	6.5	9	7	9	9	9	11.5	11.5	11.5	

Notes:

(1) Mechanical interface 130S

Mechanical tolerances

Dimensions and tolerances of shaft extension, key and flange are in accordance with IEC 60072-1. Shaft extension features an axial threaded hole in accordance with UNI 3221, DIN 332. Tolerances for the different parts are reported in the table.

Component		Dimensions	Tolerance
Shaft end	D [mm]	Ø 9 - 28	j6
		Ø 32	k6
Key	F [mm]		h9
Flange	N [mm]	Ø < 250	j6

Shaft loads

The loads in the following tables have been calculated using ISO 281 calculation L_{10h} (20.000h). The loads and speeds used are considered to be constant throughout the life of the bearing. The radial load F_R is applied to the half shaft end length.

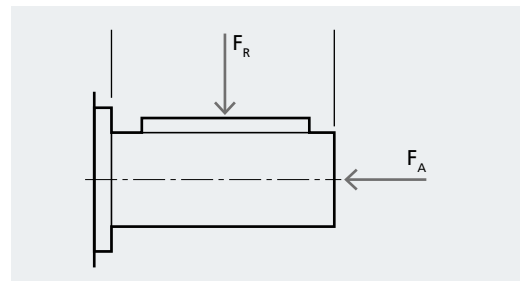

Maximum radial load F_R [N]

Size	Speed [min ⁻¹]					
	[Nm]	1600	3000	4500	5500	6000
BMD 65	0.85	300	240	210	200	190
	1.7	330	270	230	220	210
	2.2	350	280	250	230	220
BMD 82	3.2	580	470	410	390	370
	4.4	610	500	430	410	390
BMD 102	7.2	750	610	530	500	480
	9.6	800	650	570	530	520
BMD 118	10.2	860	700	610	570	550
	14	910	740	650	600	590
BMD 145	16.8	1400	1150	1000	940	910
	22	1500	1200	1050	980	960
BMD 170	34	900	730	640	-	
	45	1500	1200	1050		

Maximum axial load F_A [N]

Size	Speed [min ⁻¹]					
	[Nm]	1600	3000	4500	5500	6000
BMD 65	0.85	59	48	42	39	38
	1.7	65	53	46	43	42
	2.2	69	56	49	46	44
BMD 82	3.2	115	94	82	77	75
	4.4	120	100	85	81	79
BMD 102	7.2	150	120	105	100	95
	9.6	160	130	110	105	100
BMD 118	10.2	170	139	121	115	110
	14	180	145	130	120	115
BMD 145	16.8	280	230	200	185	180
	22	295	240	210	195	190
BMD 170	34	180	145	125	-	
	45	295	240	210		

Torque-speed characteristic

The permissible operating range of a brushless servomotor is limited by thermal, mechanical, and electromagnetic limits.

The thermal limit is dependent on the thermal class of the insulation system (F). To adhere to the temperature limits, the torque must be reduced as the speed increases, starting from stall torque M_0 . The maximum permissible torque is then dependent on the operation mode. The characteristic curves are assigned for continuous duty S1 and intermittent periodic duty (S3-20%, S3-50%). A transient, high overload capacity up to M_{max} is provided.

The speed range is limited by the maximum mechanical speed and the voltage limit. The voltage limit is usually lower than the mechanical limit. The voltage limiting characteristic curve is determined by the motor nominal speed. The

characteristic curves for each nominal speed are reported in the same diagram. For drive sizing convenience, it is preferable to select the motor whose voltage limit curve does not lie too far above the maximum speed required for the application.

Therefore, the performance characteristics of a brushless motor are described by a torque and speed operating area. The continuous duty zone is bordered by the maximum continuous torque curve up to the intersection with the voltage limit curve. Continuous duty in the area above the S1 characteristic curve is not thermally permitted for the motor. The intermittent periodic duty zone is bordered by the peak torque line and the voltage limit curve.

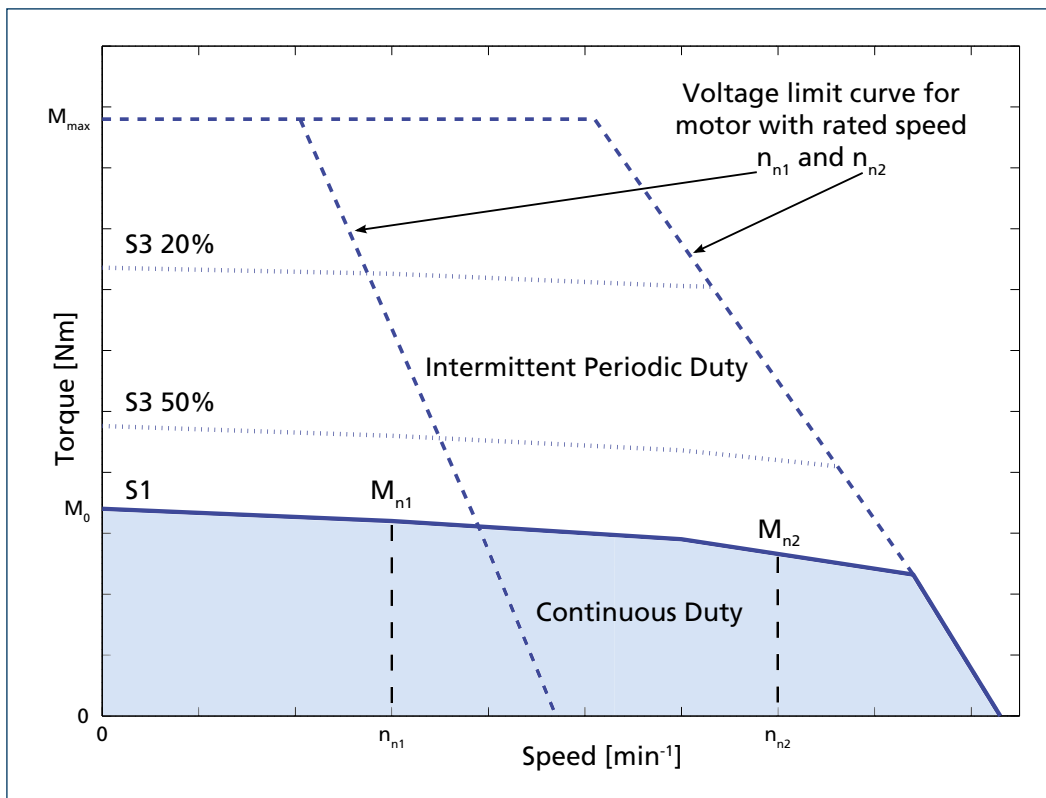

BMD 65 • 0.85 Nm - 230V

Parameter	Symbol	Unit	Speed [min ⁻¹]				
			1600	3000	4500	5500	6000
Standstill torque (dT=105K)	M_0	[Nm]	0.85				
Motor rated frequency	f_n	[Hz]	107	200	300	367	400
Motor rated voltage	V_n	[V _{AC}]	168	181	172	179	177
Rated Torque (dT=105K)	M_n	[Nm]	0.83	0.80	0.76	0.74	0.73
Current at rated speed	I_n	[A]	0.74	1.16	1.74	1.92	2.09
Standstill current	I_0	[A]	0.77	1.23	1.93	2.18	2.39
Max Torque	M_{max}	[Nm]	2.55	2.55	2.55	2.55	2.55
Max Current	I_{max}	[A]	2.5	3.9	6.2	7.0	7.7
Back EMF constant	K_e	[V/1000min ⁻¹]	75	47	30	27	24
Torque constant	K_T	[Nm/A]	1.10	0.69	0.44	0.39	0.36
Rated Power	P_n	[kW]	0.14	0.25	0.36	0.43	0.46
Stator phase-phase Resistance (at 20°C)	R_{pp}	[Ω]	48.4	19.2	7.75	6.10	5.04
Stator phase-phase Inductance	L_{pp}	[mH]	145	57.5	23.2	18.3	15.1
Rotor inertia	J_m	[kgm ² × 10 ⁻⁴]	0.2				
Electric time constant (at 20°C)	τ_{el}	[ms]	3.0				
Thermal time constant	τ_{therm}	[min]	14				
Motor mass without brake	m_M	[kg]	1.3				
Motor mass with brake	m_{MB}	[kg]	1.5				

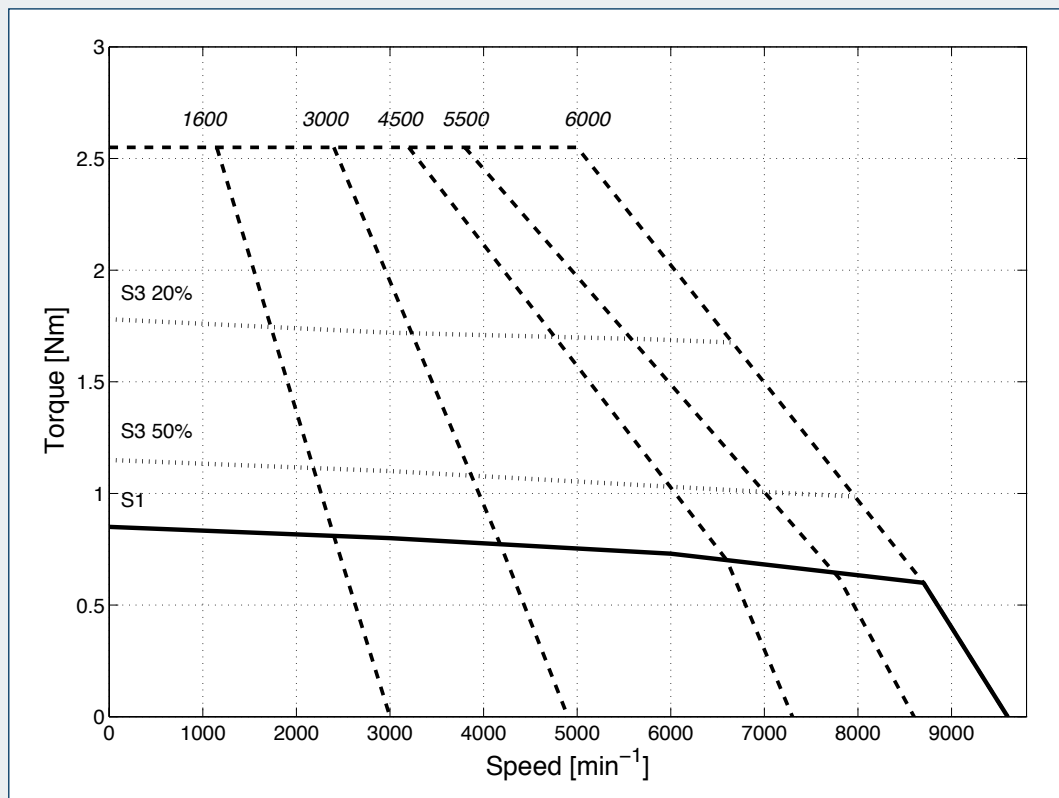

BMD 65 • 1.7 Nm - 230V

Parameter	Symbol	Unit	Speed [min^{-1}]				
			1600	3000	4500	5500	6000
Standstill torque (dT=105K)	M_0	[Nm]	1.7				
Motor rated frequency	f_n	[Hz]	107	200	300	367	400
Motor rated voltage	V_n	[V _{AC}]	193	180	180	174	171
Rated Torque (dT=105K)	M_n	[Nm]	1.65	1.60	1.52	1.48	1.45
Current at rated speed	I_n	[A]	1.25	2.30	3.2	3.9	4.2
Standstill current	I_0	[A]	1.26	2.34	3.4	4.2	4.7
Max Torque	M_{max}	[Nm]	4.9	4.9	4.9	4.9	4.9
Max Current	I_{max}	[A]	4.3	8.0	11.5	14.5	15.9
Back EMF constant	K_e	[V/1000 min^{-1}]	89	48	33	26	24
Torque constant	K_T	[Nm/A]	1.35	0.73	0.50	0.40	0.36
Rated Power	P_n	[kW]	0.28	0.50	0.72	0.85	0.91
Stator phase-phase Resistance (at 20°C)	R_{pp}	[Ω]	30.4	8.79	4.19	2.66	2.20
Stator phase-phase Inductance	L_{pp}	[mH]	91.9	26.6	12.6	8.0	6.6
Rotor inertia	J_m	[$\text{kgm}^2 \times 10^{-4}$]	0.4				
Electric time constant (at 20°C)	τ_{el}	[ms]	3.0				
Thermal time constant	τ_{therm}	[min]	20				
Motor mass without brake	m_M	[kg]	1.9				
Motor mass with brake	m_{MB}	[kg]	2.1				

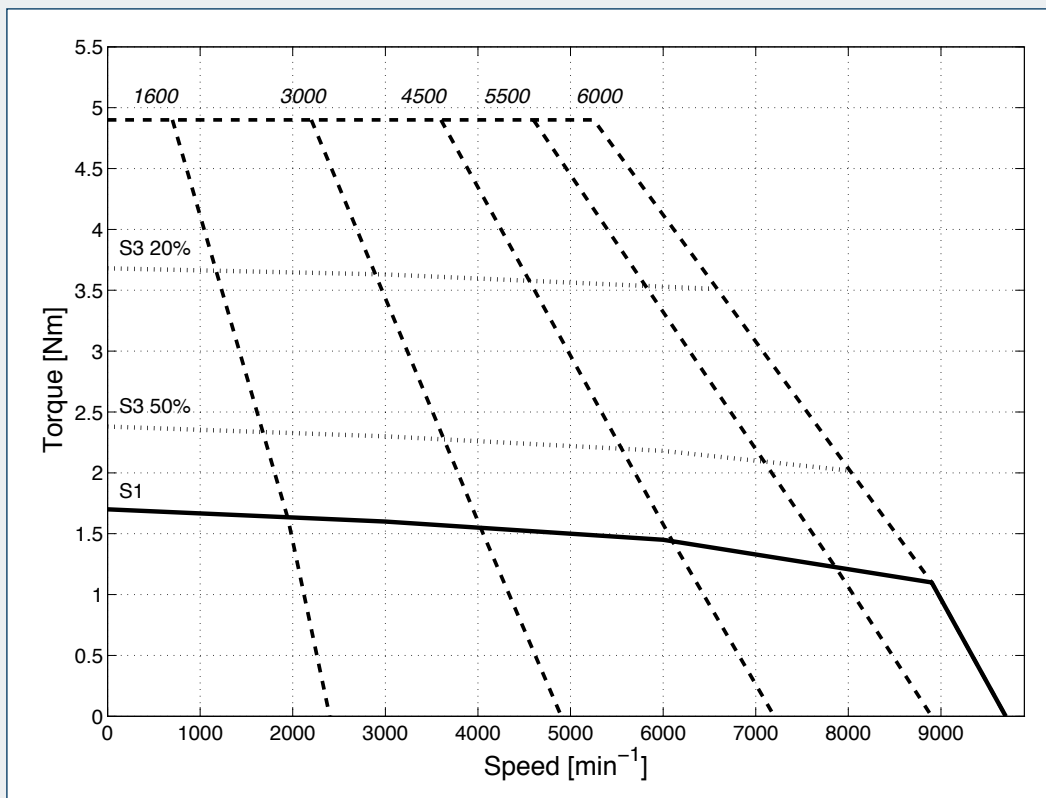

BMD 65 • 2.2 Nm - 230V

Parameter	Symbol	Unit	Speed [min ⁻¹]				
			1600	3000	4500	5500	6000
Standstill torque (dT=105K)	M ₀	[Nm]	2.2				
Motor rated frequency	f _n	[Hz]	107	200	300	367	400
Motor rated voltage	V _n	[V _{AC}]	179	180	191	192	190
Rated Torque (dT=105K)	M _n	[Nm]	2.12	2.05	1.95	1.85	1.80
Current at rated speed	I _n	[A]	1.65	2.78	3.6	4.1	4.4
Standstill current	I ₀	[A]	1.70	2.96	4.1	4.9	5.4
Max Torque	M _{max}	[Nm]	6.2	6.2	6.2	6.2	6.2
Max Current	I _{max}	[A]	5.4	9.4	12.9	15.6	17.1
Back EMF constant	K _e	[V/1000min ⁻¹]	90	52	38	31	28
Torque constant	K _T	[Nm/A]	1.29	0.74	0.54	0.45	0.41
Rated Power	P _n	[kW]	0.36	0.64	0.92	1.07	1.13
Stator phase-phase Resistance (at 20°C)	R _{pp}	[Ω]	18.8	6.21	3.27	2.26	1.86
Stator phase-phase Inductance	L _{pp}	[mH]	56.9	18.8	9.9	6.8	5.6
Rotor inertia	J _m	[kgm ² × 10 ⁻⁴]	0.6				
Electric time constant (at 20°C)	τ _{el}	[ms]	3.0				
Thermal time constant	τ _{therm}	[min]	26				
Motor mass without brake	m _M	[kg]	2.6				
Motor mass with brake	m _{MB}	[kg]	2.8				

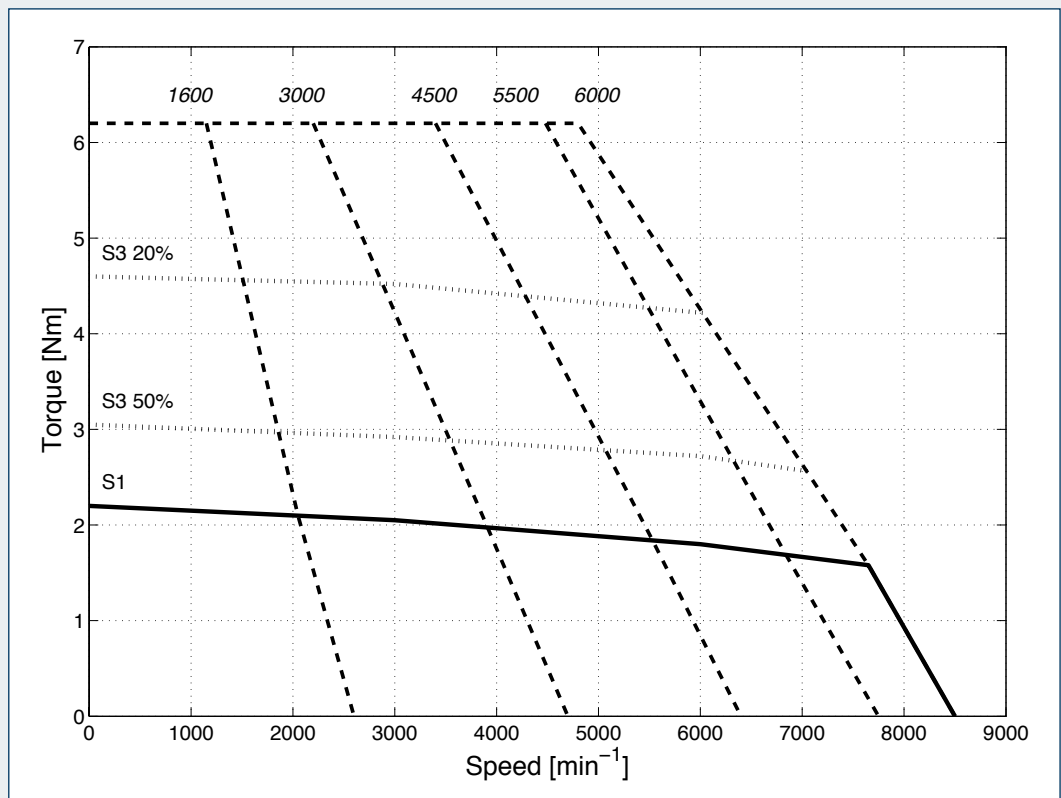

BMD 82 • 3.2 Nm - 230V

Parameter	Symbol	Unit	Speed [min^{-1}]				
			1600	3000	4500	5500	6000
Standstill torque (dT=105K)	M_0	[Nm]	3.2				
Motor rated frequency	f_n	[Hz]	107	200	300	367	400
Motor rated voltage	V_n	[V _{AC}]	191	181	200	176	176
Rated Torque (dT=105K)	M_n	[Nm]	3.15	3	2.8	2.6	2.5
Current at rated speed	I_n	[A]	2.37	4.3	5.3	7.0	7.6
Standstill current	I_0	[A]	2.41	4.5	6.0	8.3	9.0
Max Torque	M_{max}	[Nm]	8.5	8.5	8.5	8.5	8.5
Max Current	I_{max}	[A]	8.3	15.5	20.6	28.4	31
Back EMF constant	K_e	[V/1000 min^{-1}]	92	49	37	27	24
Torque constant	K_T	[Nm/A]	1.33	0.71	0.53	0.39	0.35
Rated Power	P_n	[kW]	0.53	0.94	1.32	1.50	1.57
Stator phase-phase Resistance (at 20°C)	R_{pp}	[Ω]	11.3	3.23	1.81	0.96	0.81
Stator phase-phase Inductance	L_{pp}	[mH]	64.2	18.3	10.3	5.4	4.6
Rotor inertia	J_m	[$\text{kgm}^2 \times 10^{-4}$]	1.4				
Electric time constant (at 20°C)	τ_{el}	[ms]	5.7				
Thermal time constant	τ_{therm}	[min]	26				
Motor mass without brake	m_M	[kg]	3.5				
Motor mass with brake	m_{MB}	[kg]	4.1				

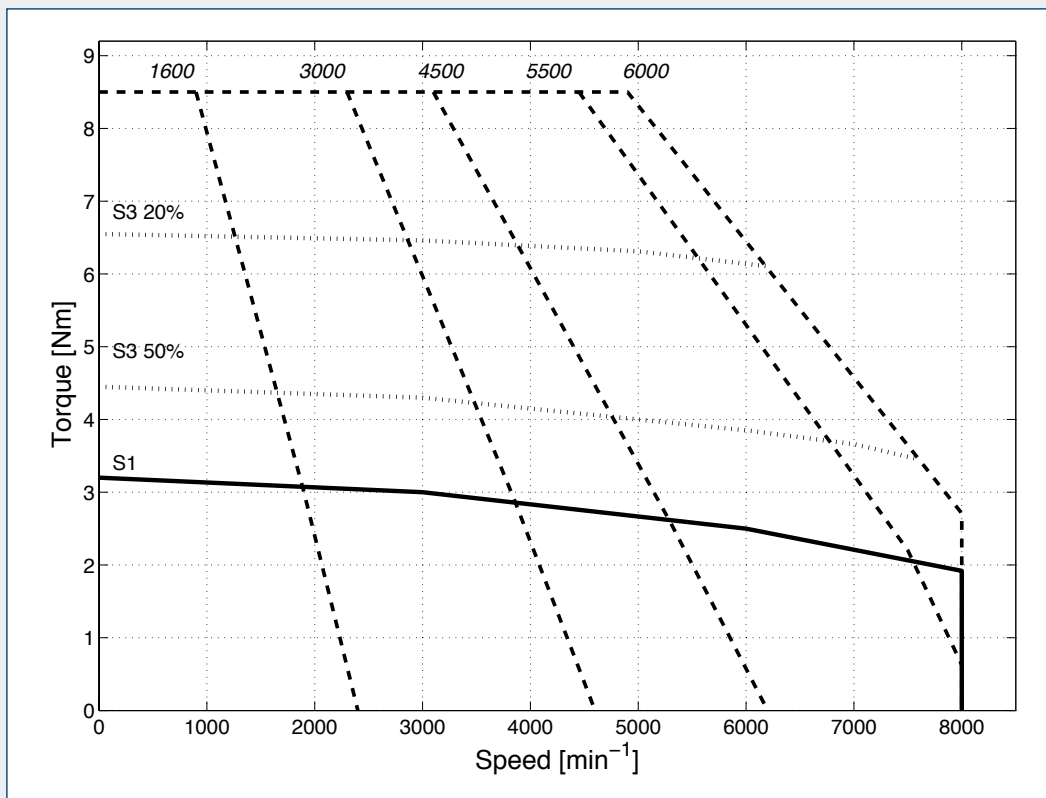

BMD 82 • 4.4 Nm - 230V

Parameter	Symbol	Unit	Speed [min ⁻¹]				
			1600	3000	4500	5500	6000
Standstill torque (dT=105K)	M ₀	[Nm]	4.4				
Motor rated frequency	f _n	[Hz]	107	200	300	367	400
Motor rated voltage	V _n	[V _{AC}]	181	184	188	196	197
Rated Torque (dT=105K)	M _n	[Nm]	4.2	3.8	3.55	3.3	3.15
Current at rated speed	I _n	[A]	3.1	5.1	6.8	7.3	7.6
Standstill current	I ₀	[A]	3.3	5.8	8.4	9.7	10.6
Max Torque	M _{max}	[Nm]	11.5	11.5	11.5	11.5	11.5
Max Current	I _{max}	[A]	9.8	17.4	25.1	29.2	32
Back EMF constant	K _e	[V/1000min ⁻¹]	93	52	36	31	29
Torque constant	K _T	[Nm/A]	1.35	0.76	0.53	0.45	0.42
Rated Power	P _n	[kW]	0.70	1.19	1.67	1.90	2.0
Stator phase-phase Resistance (at 20°C)	R _{pp}	[Ω]	6.89	2.19	1.05	0.78	0.66
Stator phase-phase Inductance	L _{pp}	[mH]	39.0	12.4	6.0	4.4	3.7
Rotor inertia	J _m	[kgm ² × 10 ⁻⁴]	1.7				
Electric time constant (at 20°C)	τ _{el}	[ms]	5.7				
Thermal time constant	τ _{therm}	[min]	33				
Motor mass without brake	m _M	[kg]	4.6				
Motor mass with brake	m _{MB}	[kg]	5.2				

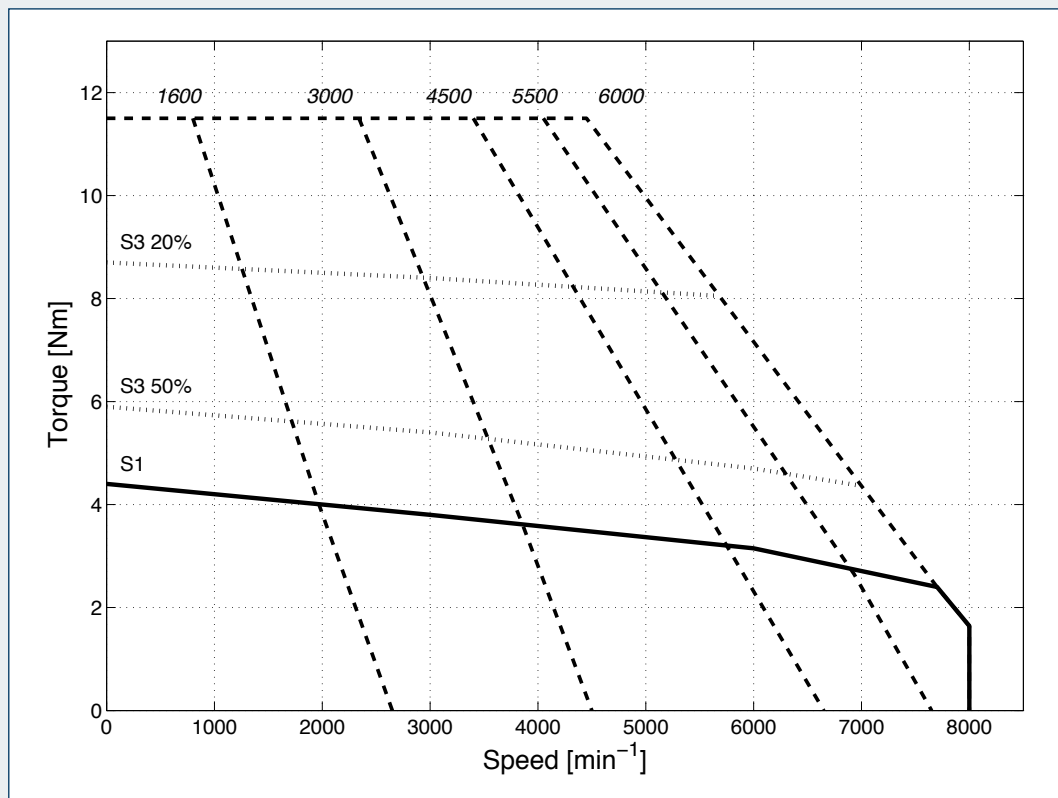

BMD 102 • 7.2 Nm - 230V

Parameter	Symbol	Unit	Speed [min^{-1}]				
			1600	3000	4500	5500	6000
Standstill torque (dT=105K)	M_0	[Nm]	7.2				
Motor rated frequency	f_n	[Hz]	107	200	300	367	400
Motor rated voltage	V_n	[V _{AC}]	187	177	182	183	185
Rated Torque (dT=105K)	M_n	[Nm]	7	6.7	6	5.8	5.6
Current at rated speed	I_n	[A]	5.0	9.5	12.6	14.4	15.4
Standstill current	I_0	[A]	5.0	9.7	13.9	16.9	18.2
Max Torque	M_{max}	[Nm]	21	21	21	21	21
Max Current	I_{max}	[A]	18.3	35	51	61	66
Back EMF constant	K_e	[V/1000 min^{-1}]	94	49	34	28	26
Torque constant	K_T	[Nm/A]	1.43	0.75	0.52	0.43	0.40
Rated Power	P_n	[kW]	1.17	2.10	2.83	3.3	3.5
Stator phase-phase Resistance (at 20°C)	R_{pp}	[Ω]	3.02	0.82	0.40	0.27	0.23
Stator phase-phase Inductance	L_{pp}	[mH]	25.4	6.9	3.3	2.3	1.9
Rotor inertia	J_m	[$\text{kgm}^2 \times 10^{-4}$]	3.4				
Electric time constant (at 20°C)	τ_{el}	[ms]	8.4				
Thermal time constant	τ_{therm}	[min]	31				
Motor mass without brake	m_M	[kg]	5.8				
Motor mass with brake	m_{MB}	[kg]	7				

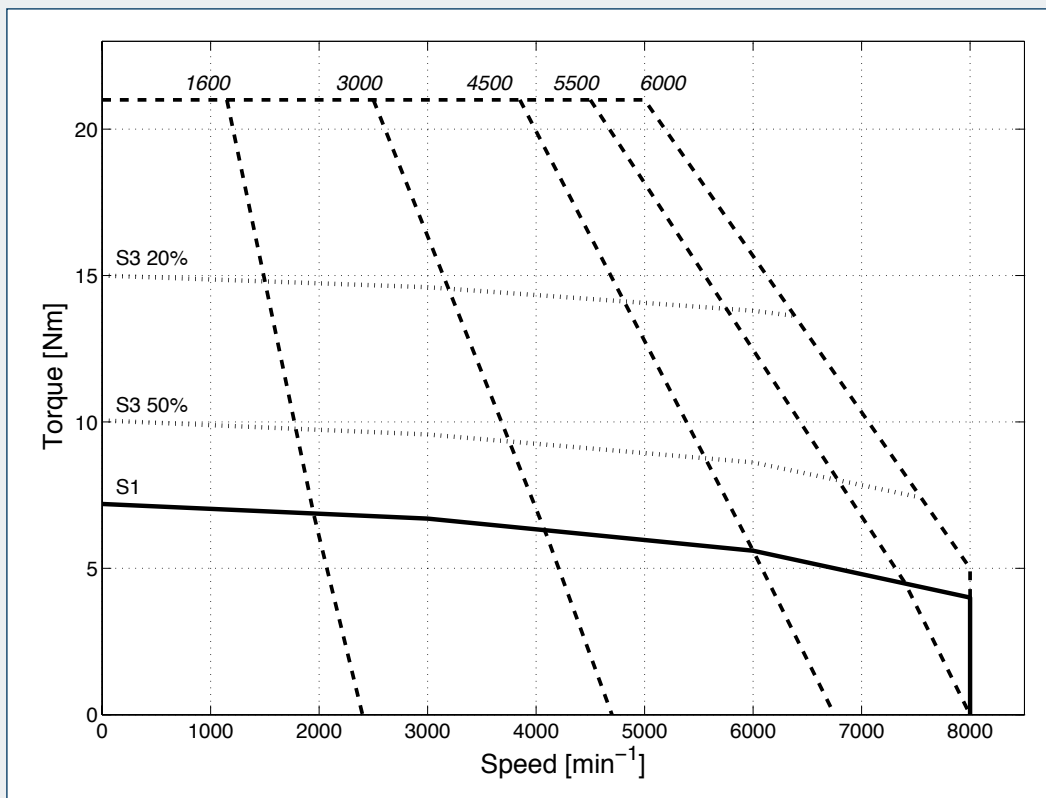

BMD 102 • 9.6 Nm - 230V

Parameter	Symbol	Unit	Speed [min ⁻¹]				
			1600	3000	4500	5500	6000
Standstill torque (dT=105K)	M ₀	[Nm]	9.6				
Motor rated frequency	f _n	[Hz]	107	200	300	367	400
Motor rated voltage	V _n	[V _{AC}]	183	184	187	192	190
Rated Torque (dT=105K)	M _n	[Nm]	9.2	8.5	7.7	6.9	6.5
Current at rated speed	I _n	[A]	6.0	10.2	13.5	14.3	14.8
Standstill current	I ₀	[A]	6.3	11.5	16.8	19.8	21.8
Max Torque	M _{max}	[Nm]	28	28	28	28	28
Max Current	I _{max}	[A]	20.4	37	54	64	70
Back EMF constant	K _e	[V/1000min ⁻¹]	102	56	38	33	30
Torque constant	K _T	[Nm/A]	1.52	0.84	0.57	0.48	0.44
Rated Power	P _n	[kW]	1.54	2.7	3.6	4.0	4.1
Stator phase-phase Resistance (at 20°C)	R _{pp}	[Ω]	2.24	0.68	0.32	0.23	0.19
Stator phase-phase Inductance	L _{pp}	[mH]	18.8	5.7	2.7	1.9	1.6
Rotor inertia	J _m	[kgm ² × 10 ⁻⁴]	4.7				
Electric time constant (at 20°C)	τ _{el}	[ms]	8.4				
Thermal time constant	τ _{therm}	[min]	38				
Motor mass without brake	m _M	[kg]	7.4				
Motor mass with brake	m _{MB}	[kg]	8.6				

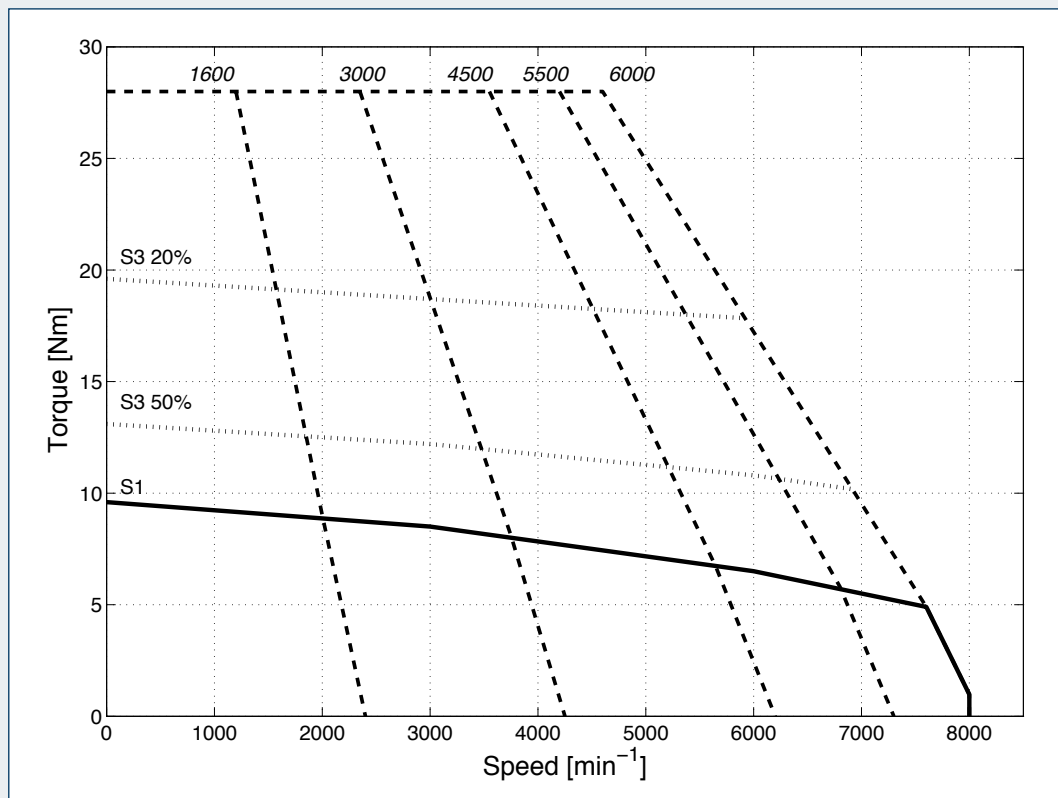

BMD 118 • 10.2 Nm - 230V

Parameter	Symbol	Unit	Speed [min^{-1}]			
			1600	3000	4500	5500
Standstill torque (dT=105K)	M_0	[Nm]	10.2			
Motor rated frequency	f_n	[Hz]	107	200	300	367
Motor rated voltage	V_n	[V _{AC}]	184	178	174	196
Rated Torque (dT=105K)	M_n	[Nm]	10	9.5	8.5	8
Current at rated speed	I_n	[A]	7.2	13.5	18.3	17.4
Standstill current	I_0	[A]	7.2	13.7	20.8	22.6
Max Torque	M_{max}	[Nm]	30	30	30	30
Max Current	I_{max}	[A]	25.3	48	73	79
Back EMF constant	K_e	[V/1000 min^{-1}]	95	50	33.1	30.4
Torque constant	K_T	[Nm/A]	1.41	0.75	0.49	0.45
Rated Power	P_n	[kW]	1.7	3.0	4.0	4.6
Stator phase-phase Resistance (at 20°C)	R_{pp}	[Ω]	1.56	0.43	0.19	0.16
Stator phase-phase Inductance	L_{pp}	[mH]	20.5	5.7	2.5	2.1
Rotor inertia	J_m	[$\text{kgm}^2 \times 10^{-4}$]	7.8			
Electric time constant (at 20°C)	τ_{el}	[ms]	13			
Thermal time constant	τ_{therm}	[min]	34			
Motor mass without brake	m_M	[kg]	9.7			
Motor mass with brake	m_{MB}	[kg]	11.9			

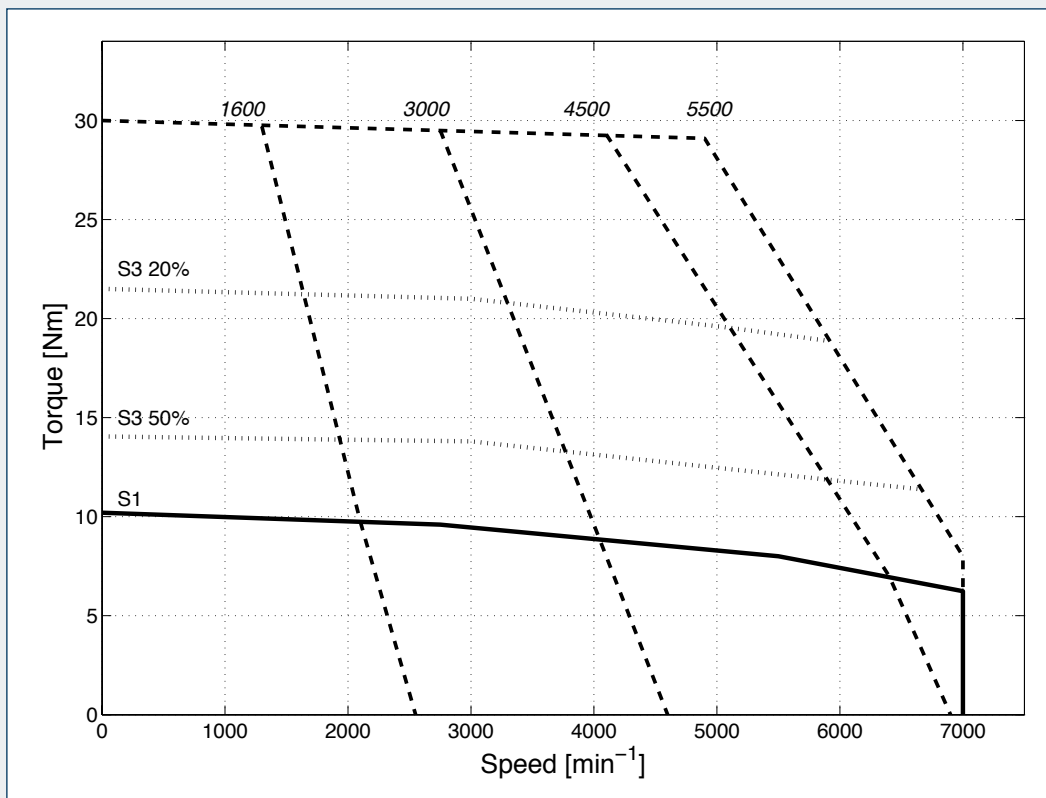

BMD 118 • 14 Nm - 230V

Parameter	Symbol	Unit	Speed [min ⁻¹]	
			1600	3000
Standstill torque (dT=105K)	M ₀	[Nm]	14.0	
Motor rated frequency	f _n	[Hz]	107	200
Motor rated voltage	V _n	[V _{AC}]	184	192
Rated Torque (dT=105K)	M _n	[Nm]	13.3	12.2
Current at rated speed	I _n	[A]	8.6	14.0
Standstill current	I ₀	[A]	9.2	16.3
Max Torque	M _{max}	[Nm]	39	39
Max Current	I _{max}	[A]	30	53
Back EMF constant	K _e	[V/1000min ⁻¹]	104	59
Torque constant	K _T	[Nm/A]	1.51	0.86
Rated Power	P _n	[kW]	2.2	3.8
Stator phase-phase Resistance (at 20°C)	R _{pp}	[Ω]	1.17	0.37
Stator phase-phase Inductance	L _{pp}	[mH]	15.4	4.9
Rotor inertia	J _m	[kgm ² x 10 ⁻⁴]	9.9	
Electric time constant (at 20°C)	τ _{el}	[ms]	13	
Thermal time constant	τ _{therm}	[min]	42	
Motor mass without brake	m _M	[kg]	11.7	
Motor mass with brake	m _{MB}	[kg]	12.9	

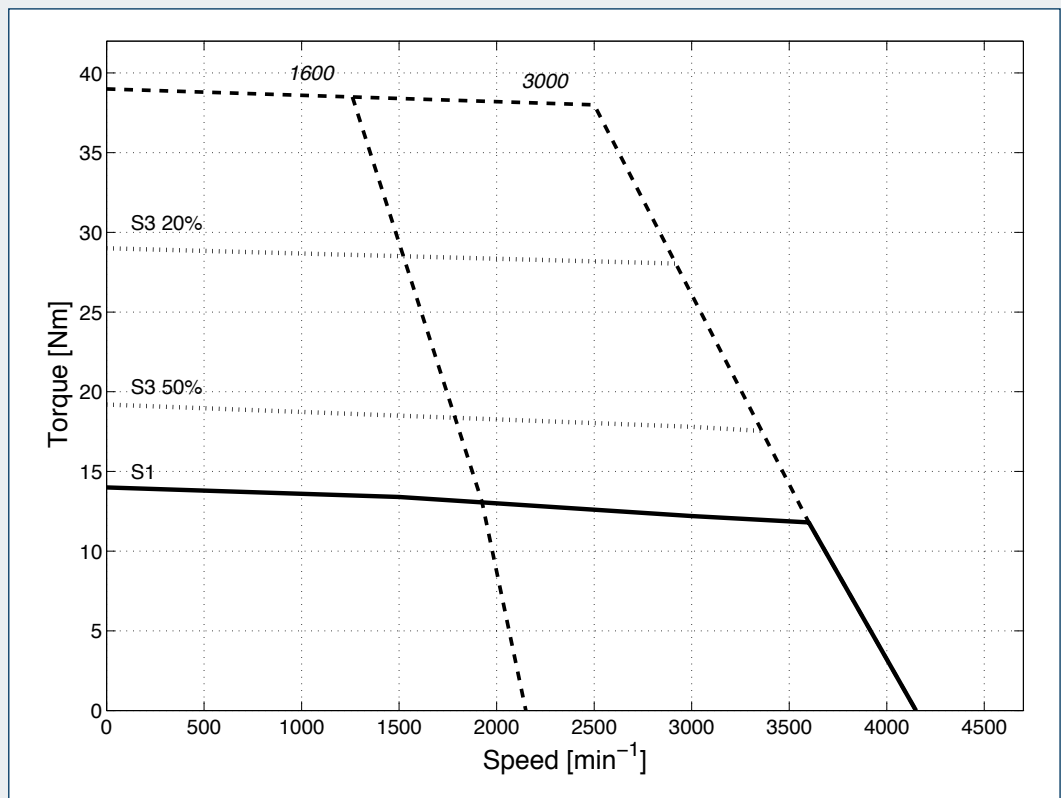

BMD 145 • 16.8 Nm - 230V

Parameter	Symbol	Unit	Speed [min ⁻¹]	
			1600	3000
Standstill torque (dT=105K)	M ₀	[Nm]	16.8	
Motor rated frequency	f _n	[Hz]	107	200
Motor rated voltage	V _n	[V _{AC}]	180	176
Rated Torque (dT=105K)	M _n	[Nm]	16.5	16
Current at rated speed	I _n	[A]	11.9	21.9
Standstill current	I ₀	[A]	12.1	22.8
Max Torque	M _{max}	[Nm]	46	46
Max Current	I _{max}	[A]	46	88
Back EMF constant	K _e	[V/1000min ⁻¹]	89	47
Torque constant	K _T	[Nm/A]	1.39	0.74
Rated Power	P _n	[kW]	2.76	5.0
Stator phase-phase Resistance (at 20°C)	R _{pp}	[Ω]	0.84	0.24
Stator phase-phase Inductance	L _{pp}	[mH]	13.3	3.8
Rotor inertia	J _m	[kgm ² x 10 ⁻⁴]	12.8	
Electric time constant (at 20°C)	τ _{el}	[ms]	16	
Thermal time constant	τ _{therm}	[min]	36	
Motor mass without brake	m _M	[kg]	15.2	
Motor mass with brake	m _{MB}	[kg]	17.8	

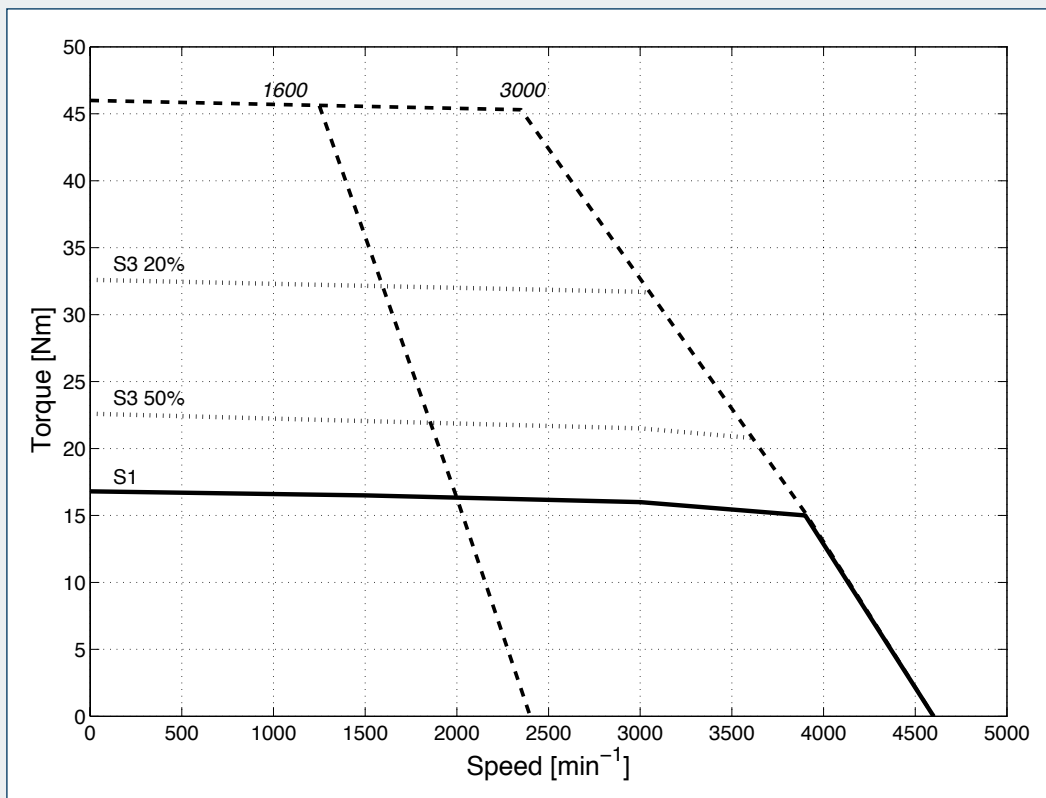

BMD 145 • 22 Nm - 230V

Parameter	Symbol	Unit	Speed [min^{-1}]	
			1600	3000
Standstill torque (dT=105K)	M_0	[Nm]	22.0	
Motor rated frequency	f_n	[Hz]	107	200
Motor rated voltage	V_n	[V _{AC}]	185	202
Rated Torque (dT=105K)	M_n	[Nm]	20.7	19.2
Current at rated speed	I_n	[A]	14.5	22.9
Standstill current	I_0	[A]	15.4	26.5
Max Torque	M_{max}	[Nm]	59	59
Max Current	I_{max}	[A]	51	87
Back EMF constant	K_e	[V/1000 min^{-1}]	102	60
Torque constant	K_T	[Nm/A]	1.42	0.83
Rated Power	P_n	[kW]	3.5	6.0
Stator phase-phase Resistance (at 20°C)	R_{pp}	[Ω]	0.67	0.23
Stator phase-phase Inductance	L_{pp}	[mH]	10.6	3.6
Rotor inertia	J_m	[$\text{kgm}^2 \times 10^{-4}$]	17.6	
Electric time constant (at 20°C)	τ_{el}	[ms]	16	
Thermal time constant	τ_{therm}	[min]	47	
Motor mass without brake	m_M	[kg]	18.2	
Motor mass with brake	m_{MB}	[kg]	20.8	

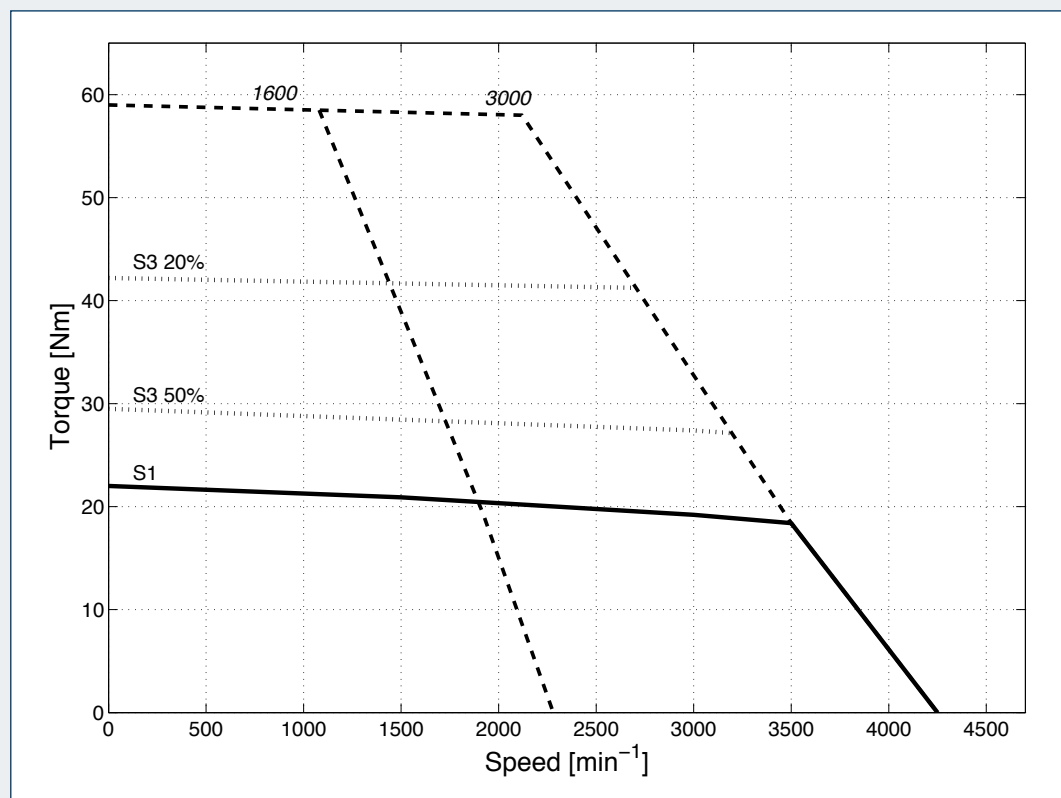

BMD 170 • 34 Nm - 230V

Parameter	Symbol	Unit	Speed [min^{-1}]	
			1600	3000
Standstill torque (dT=105K)	M_0	[Nm]	34.0	
Motor rated frequency	f_n	[Hz]	107	200
Motor rated voltage	V_n	[V _{AC}]	181	182
Rated Torque (dT=105K)	M_n	[Nm]	31	27.5
Current at rated speed	I_n	[A]	19.7	32.2
Standstill current	I_0	[A]	21.8	40.4
Max Torque	M_{max}	[Nm]	90	90
Max Current	I_{max}	[A]	66	121
Back EMF constant	K_e	[V/1000 min^{-1}]	99	54
Torque constant	K_T	[Nm/A]	1.56	0.84
Rated Power	P_n	[kW]	5.2	8.6
Stator phase-phase Resistance (at 20°C)	R_{pp}	[Ω]	0.30	0.09
Stator phase-phase Inductance	L_{pp}	[mH]	5.8	1.7
Rotor inertia	J_m	[$\text{kgm}^2 \times 10^{-4}$]	28.2	
Electric time constant (at 20°C)	τ_{el}	[ms]	20	
Thermal time constant	τ_{therm}	[min]	50	
Motor mass without brake	m_M	[kg]	25	
Motor mass with brake	m_{MB}	[kg]	29.5	

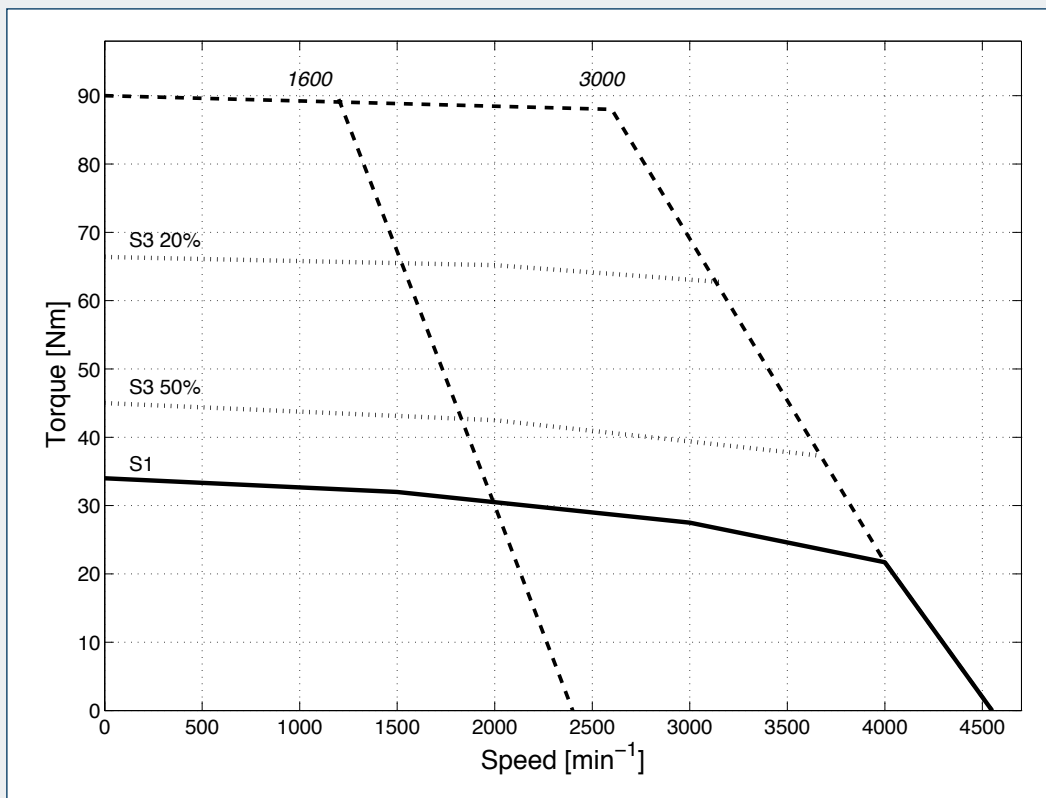

BMD 65 • 0.85 Nm - 400V

Parameter	Symbol	Unit	Speed [min^{-1}]			
			3000	4500	5500	6000
Standstill torque (dT=105K)	M_0	[Nm]	0.85			
Motor rated frequency	f_n	[Hz]	200	300	367	400
Motor rated voltage	V_n	[V _{AC}]	295	331	318	306
Rated Torque (dT=105K)	M_n	[Nm]	0.80	0.76	0.74	0.73
Current at rated speed	I_n	[A]	0.72	0.88	1.08	1.21
Standstill current	I_0	[A]	0.76	0.98	1.23	1.38
Max Torque	M_{max}	[Nm]	2.55	2.55	2.55	2.55
Max Current	I_{max}	[A]	2.43	3.1	3.9	4.4
Back EMF constant	K_e	[V/1000 min^{-1}]	76	59	47	42
Torque constant	K_T	[Nm/A]	1.12	0.87	0.69	0.62
Rated Power	P_n	[kW]	0.25	0.36	0.43	0.46
Stator phase-phase Resistance (at 20°C)	R_{pp}	[Ω]	50.0	30.3	19.2	15.1
Stator phase-phase Inductance	L_{pp}	[mH]	150	90.7	57.5	45.2
Rotor inertia	J_m	[$\text{kgm}^2 \times 10^{-4}$]	0.2			
Electric time constant (at 20°C)	τ_{el}	[ms]	3.0			
Thermal time constant	τ_{therm}	[min]	14			
Motor mass without brake	m_M	[kg]	1.3			
Motor mass with brake	m_{MB}	[kg]	1.5			

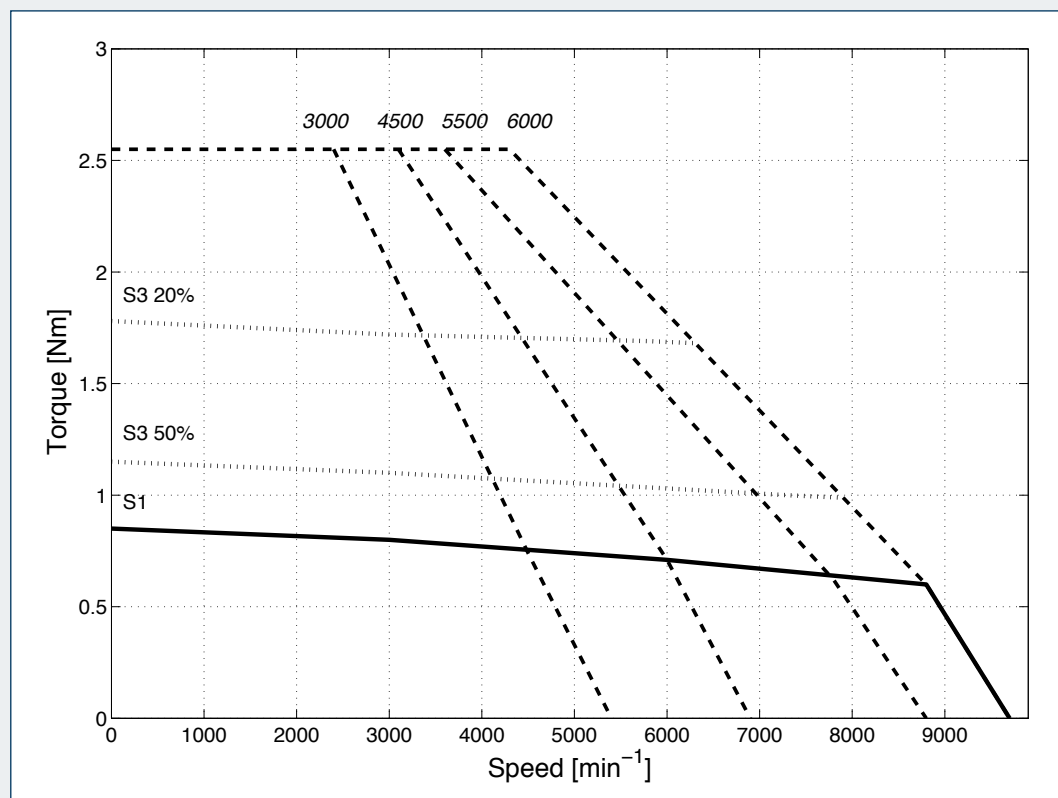

BMD 65 • 1.7 Nm - 400V

Parameter	Symbol	Unit	Speed [min ⁻¹]				
			1600	3000	4500	5500	6000
Standstill torque (dT=105K)	M ₀	[Nm]	1.7				
Motor rated frequency	f _n	[Hz]	107	200	300	367	400
Motor rated voltage	V _n	[V _{AC}]	336	311	308	316	300
Rated Torque (dT=105K)	M _n	[Nm]	1.65	1.60	1.52	1.48	1.45
Current at rated speed	I _n	[A]	0.72	1.33	1.85	2.14	2.43
Standstill current	I ₀	[A]	0.72	1.35	1.98	2.34	2.68
Max Torque	M _{max}	[Nm]	4.9	4.9	4.9	4.9	4.9
Max Current	I _{max}	[A]	2.46	4.6	6.7	8.0	9.1
Back EMF constant	K _e	[V/1000min ⁻¹]	155	83	57	48	42
Torque constant	K _T	[Nm/A]	2.36	1.26	0.86	0.73	0.63
Rated Power	P _n	[kW]	0.28	0.50	0.72	0.85	0.91
Stator phase-phase Resistance (at 20°C)	R _{pp}	[Ω]	92.3	26.3	12.2	8.79	6.65
Stator phase-phase Inductance	L _{pp}	[mH]	279	79.5	37.0	26.6	20.1
Rotor inertia	J _m	[kgm ² x 10 ⁻⁴]	0.4				
Electric time constant (at 20°C)	τ _{el}	[ms]	3.0				
Thermal time constant	τ _{therm}	[min]	20				
Motor mass without brake	m _M	[kg]	1.9				
Motor mass with brake	m _{MB}	[kg]	2.1				

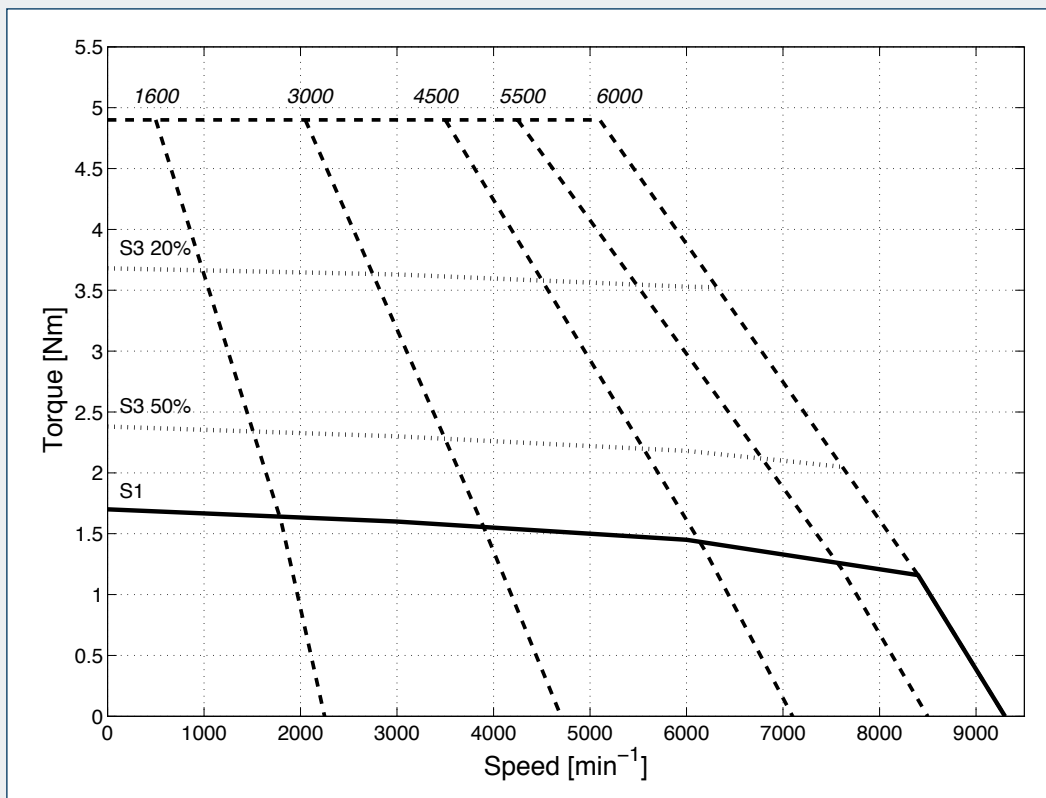

BMD 65 • 2.2 Nm - 400V

Parameter	Symbol	Unit	Speed [min ⁻¹]				
			1600	3000	4500	5500	6000
Standstill torque (dT=105K)	M ₀	[Nm]	2.2				
Motor rated frequency	f _n	[Hz]	107	200	300	367	400
Motor rated voltage	V _n	[V _{AC}]	285	314	314	328	313
Rated Torque (dT=105K)	M _n	[Nm]	2.12	2.05	1.95	1.85	1.80
Current at rated speed	I _n	[A]	1.04	1.60	2.20	2.41	2.68
Standstill current	I ₀	[A]	1.07	1.70	2.48	2.88	3.27
Max Torque	M _{max}	[Nm]	6.2	6.2	6.2	6.2	6.2
Max Current	I _{max}	[A]	3.4	5.4	7.9	9.1	10.4
Back EMF constant	K _e	[V/1000min ⁻¹]	143	90	62	53	47
Torque constant	K _T	[Nm/A]	2.06	1.29	0.89	0.76	0.67
Rated Power	P _n	[kW]	0.36	0.64	0.92	1.07	1.13
Stator phase-phase Resistance (at 20°C)	R _{pp}	[Ω]	47.6	18.8	8.82	6.56	5.08
Stator phase-phase Inductance	L _{pp}	[mH]	144	56.9	26.7	19.8	15.4
Rotor inertia	J _m	[kgm ² x 10 ⁻⁴]	0.6				
Electric time constant (at 20°C)	τ _{el}	[ms]	3.0				
Thermal time constant	τ _{therm}	[min]	26				
Motor mass without brake	m _M	[kg]	2.6				
Motor mass with brake	m _{MB}	[kg]	2.8				

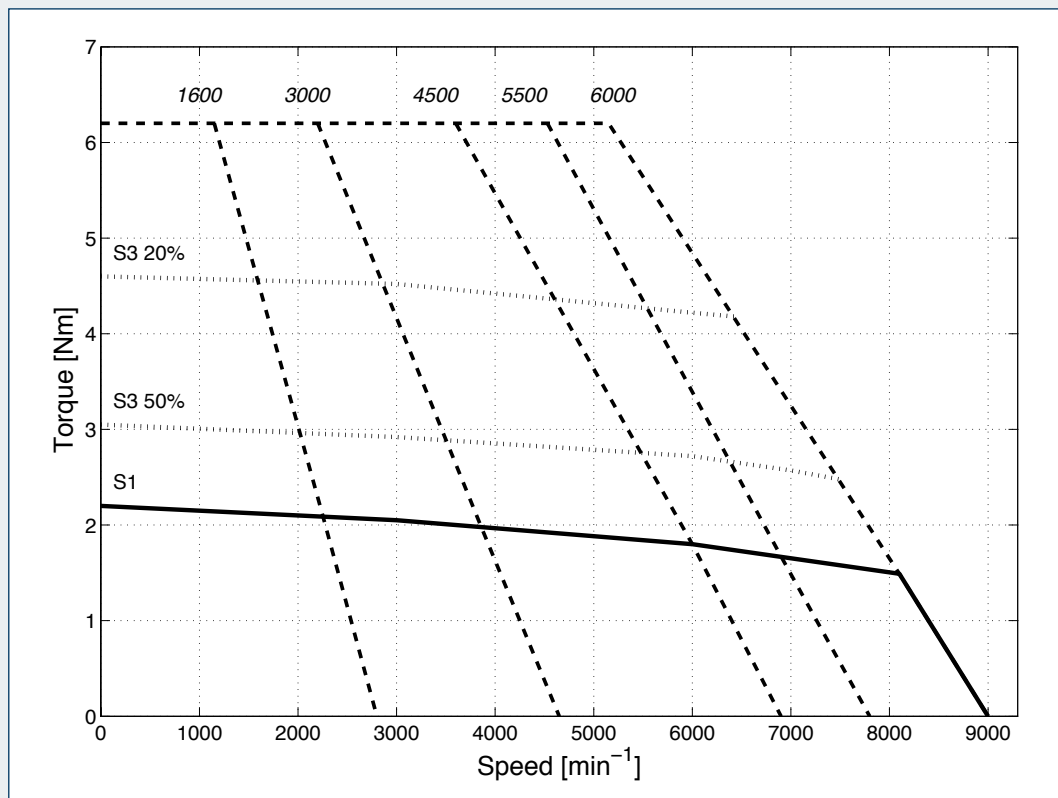

BMD 82 • 3.2 Nm - 400V

Parameter	Symbol	Unit	Speed [min^{-1}]				
			1600	3000	4500	5500	6000
Standstill torque (dT=105K)	M_0	[Nm]	3.2				
Motor rated frequency	f_n	[Hz]	107	200	300	367	400
Motor rated voltage	V_n	[V _{AC}]	332	315	312	323	308
Rated Torque (dT=105K)	M_n	[Nm]	3.15	3	2.8	2.6	2.5
Current at rated speed	I_n	[A]	1.36	2.50	3.4	3.8	4.3
Standstill current	I_0	[A]	1.39	2.60	3.9	4.5	5.2
Max Torque	M_{max}	[Nm]	8.5	8.5	8.5	8.5	8.5
Max Current	I_{max}	[A]	4.7	8.9	13.2	15.5	17.7
Back EMF constant	K_e	[V/1000 min^{-1}]	159	85	57	49	43
Torque constant	K_T	[Nm/A]	2.31	1.23	0.83	0.71	0.62
Rated Power	P_n	[kW]	0.53	0.94	1.32	1.50	1.57
Stator phase-phase Resistance (at 20°C)	R_{pp}	[Ω]	34.3	9.75	4.42	3.23	2.47
Stator phase-phase Inductance	L_{pp}	[mH]	194	55.2	25.0	18.3	14.0
Rotor inertia	J_m	[$\text{kgm}^2 \times 10^{-4}$]	1.4				
Electric time constant (at 20°C)	τ_{el}	[ms]	5.7				
Thermal time constant	τ_{therm}	[min]	26				
Motor mass without brake	m_M	[kg]	3.5				
Motor mass with brake	m_{MB}	[kg]	4.1				

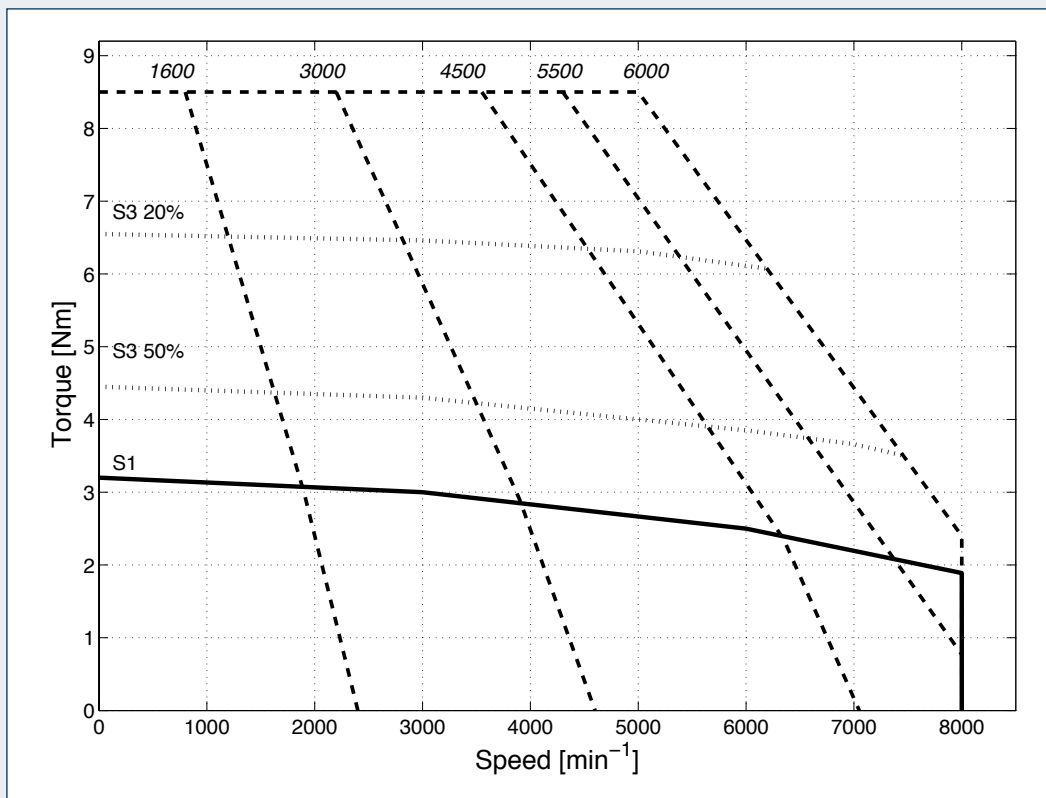

BMD 82 • 4.4 Nm - 400V

Parameter	Symbol	Unit	Speed [min ⁻¹]				
			1600	3000	4500	5500	6000
Standstill torque (dT=105K)	M ₀	[Nm]	4.4				
Motor rated frequency	f _n	[Hz]	107	200	300	367	400
Motor rated voltage	V _n	[V _{AC}]	315	323	328	335	335
Rated Torque (dT=105K)	M _n	[Nm]	4.2	3.8	3.55	3.3	3.15
Current at rated speed	I _n	[A]	1.76	2.90	3.9	4.3	4.5
Standstill current	I ₀	[A]	1.88	3.3	4.8	5.7	6.2
Max Torque	M _{max}	[Nm]	11.5	11.5	11.5	11.5	11.5
Max Current	I _{max}	[A]	5.6	9.9	14.4	17.1	18.6
Back EMF constant	K _e	[V/1000min ⁻¹]	161	92	63	53	49
Torque constant	K _T	[Nm/A]	2.34	1.33	0.92	0.77	0.71
Rated Power	P _n	[kW]	0.70	1.19	1.67	1.90	2.0
Stator phase-phase Resistance (at 20°C)	R _{pp}	[Ω]	20.8	6.77	3.21	2.26	1.92
Stator phase-phase Inductance	L _{pp}	[mH]	118	38.3	18.1	12.8	10.8
Rotor inertia	J _m	[kgm ² × 10 ⁻⁴]	1.7				
Electric time constant (at 20°C)	τ _{el}	[ms]	5.7				
Thermal time constant	τ _{therm}	[min]	33				
Motor mass without brake	m _M	[kg]	4.6				
Motor mass with brake	m _{MB}	[kg]	5.2				

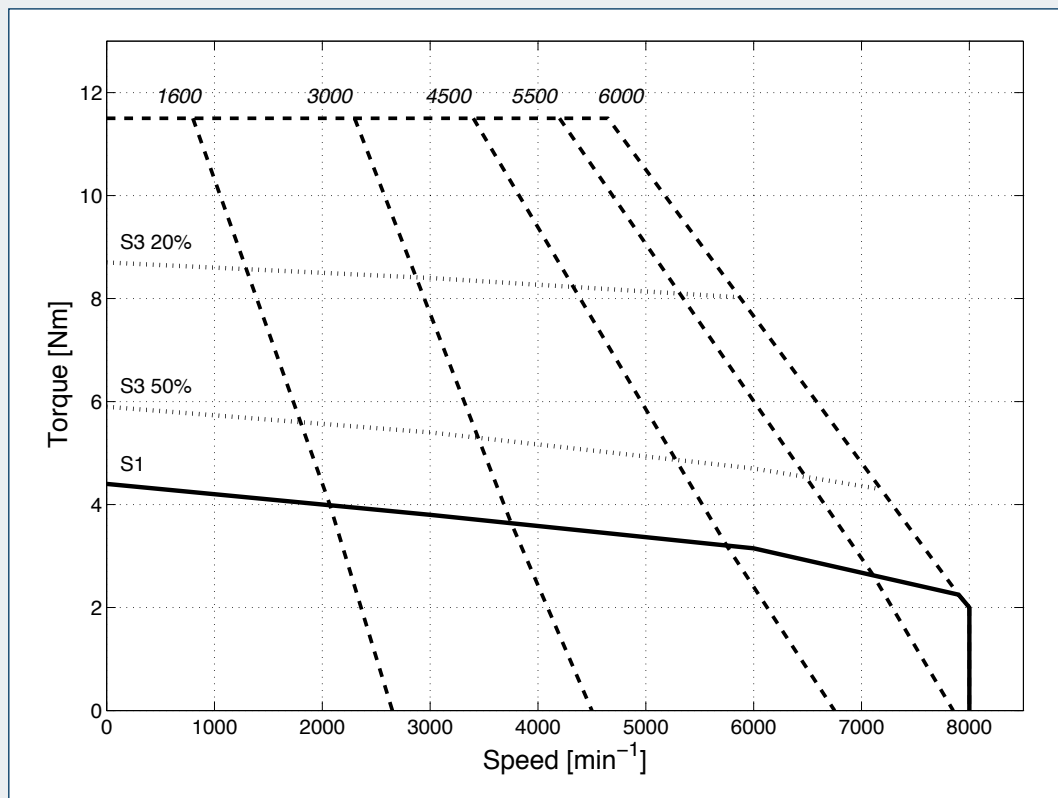

BMD 102 • 7.2 Nm - 400V

Parameter	Symbol	Unit	Speed [min^{-1}]				
			1600	3000	4500	5500	6000
Standstill torque (dT=105K)	M_0	[Nm]	7.2				
Motor rated frequency	f_n	[Hz]	107	200	300	367	400
Motor rated voltage	V_n	[V _{AC}]	320	311	305	320	305
Rated Torque (dT=105K)	M_n	[Nm]	7	6.7	6	5.8	5.6
Current at rated speed	I_n	[A]	2.92	5.4	7.5	8.2	9.3
Standstill current	I_0	[A]	2.94	5.5	8.3	9.7	11.0
Max Torque	M_{max}	[Nm]	21	21	21	21	21
Max Current	I_{max}	[A]	10.7	20.0	30	35	40
Back EMF constant	K_e	[V/1000 min^{-1}]	161	86	57	49	43
Torque constant	K_T	[Nm/A]	2.45	1.31	0.87	0.75	0.65
Rated Power	P_n	[kW]	1.17	2.10	2.83	3.3	3.5
Stator phase-phase Resistance (at 20°C)	R_{pp}	[Ω]	8.87	2.53	1.11	0.82	0.63
Stator phase-phase Inductance	L_{pp}	[mH]	74.7	21.3	9.4	6.9	5.3
Rotor inertia	J_m	[$\text{kgm}^2 \times 10^{-4}$]	3.7				
Electric time constant (at 20°C)	τ_{el}	[ms]	1.4				
Thermal time constant	τ_{therm}	[min]	31				
Motor mass without brake	m_M	[kg]	5.8				
Motor mass with brake	m_{MB}	[kg]	7				

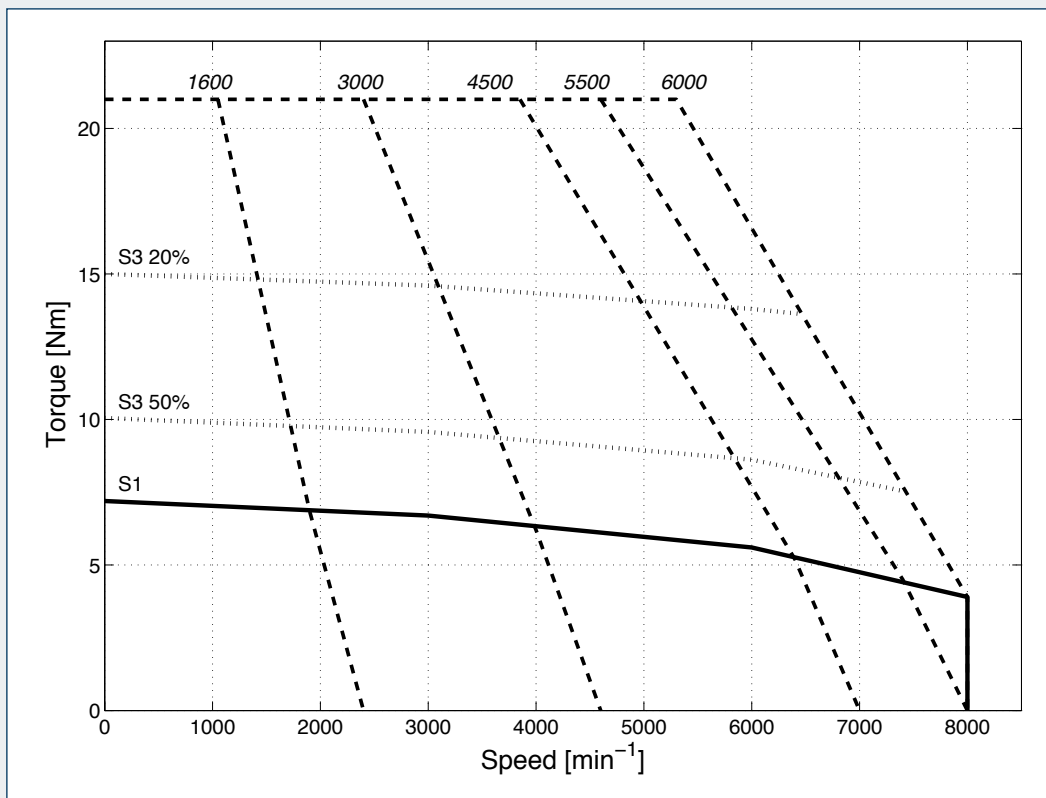

BMD 102 • 9.6 Nm - 400V

Parameter	Symbol	Unit	Speed [min ⁻¹]				
			1600	3000	4500	5500	6000
Standstill torque (dT=105K)	M ₀	[Nm]	9.6				
Motor rated frequency	f _n	[Hz]	107	200	300	367	400
Motor rated voltage	V _n	[V _{AC}]	318	324	323	332	333
Rated Torque (dT=105K)	M _n	[Nm]	9.2	8.5	7.7	6.9	6.5
Current at rated speed	I _n	[A]	3.4	5.8	7.8	8.3	8.4
Standstill current	I ₀	[A]	3.6	6.5	9.7	11.5	12.4
Max Torque	M _{max}	[Nm]	28	28	28	28	28
Max Current	I _{max}	[A]	11.7	21.0	31	37	40
Back EMF constant	K _e	[V/1000min ⁻¹]	177	99	66	56	52
Torque constant	K _T	[Nm/A]	2.65	1.48	0.99	0.84	0.77
Rated Power	P _n	[kW]	1.54	2.7	3.6	4.0	4.1
Stator phase-phase Resistance (at 20°C)	R _{pp}	[Ω]	6.77	2.11	0.95	0.68	0.58
Stator phase-phase Inductance	L _{pp}	[mH]	56.8	17.7	8.0	5.7	4.8
Rotor inertia	J _m	[kgm ² × 10 ⁻⁴]	4.7				
Electric time constant (at 20°C)	τ _{el}	[ms]	8.4				
Thermal time constant	τ _{therm}	[min]	38				
Motor mass without brake	m _M	[kg]	7.4				
Motor mass with brake	m _{MB}	[kg]	8.4				

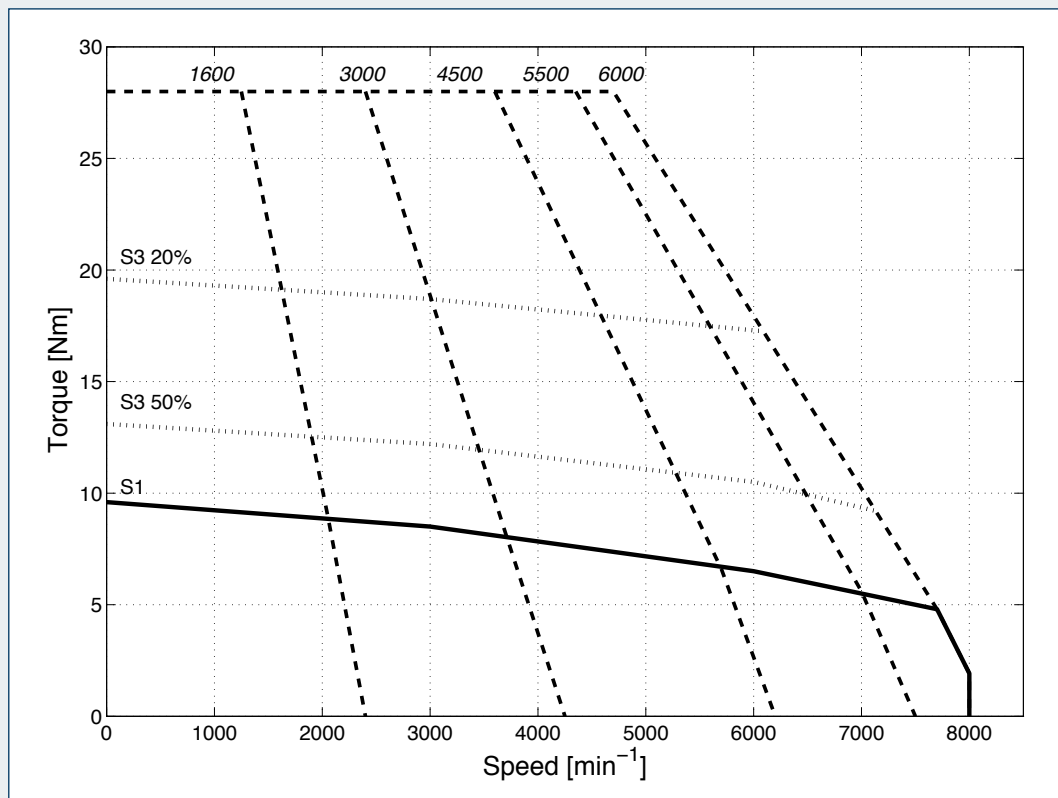

BMD 118 • 10.2 Nm - 400V

Parameter	Symbol	Unit	Speed [min ⁻¹]				
			1600	3000	4500	5500	6000
Standstill torque (dT=105K)	M ₀	[Nm]	10.2				
Motor rated frequency	f _n	[Hz]	107	200	300	367	400
Motor rated voltage	V _n	[V _{AC}]	312	305	314	323	306
Rated Torque (dT=105K)	M _n	[Nm]	10	9.5	8.5	8	7.5
Current at rated speed	I _n	[A]	4.2	7.9	10.2	10.5	11.4
Standstill current	I ₀	[A]	4.3	8.0	11.6	13.7	15.8
Max Torque	M _{max}	[Nm]	30	30	30	30	30
Max Current	I _{max}	[A]	14.9	28.0	40	48	55
Back EMF constant	K _e	[V/1000min ⁻¹]	161	86	60	50	44
Torque constant	K _T	[Nm/A]	2.39	1.28	0.88	0.75	0.65
Rated Power	P _n	[kW]	1.68	3.0	4.0	4.6	4.7
Stator phase-phase Resistance (at 20°C)	R _{pp}	[Ω]	4.47	1.27	0.61	0.43	0.33
Stator phase-phase Inductance	L _{pp}	[mH]	58.8	16.7	8.0	5.7	4.3
Rotor inertia	J _m	[kgm ² x 10 ⁻⁴]	7.8				
Electric time constant (at 20°C)	τ _{el}	[ms]	13				
Thermal time constant	τ _{therm}	[min]	34				
Motor mass without brake	m _M	[kg]	9.7				
Motor mass with brake	m _{MB}	[kg]	11.9				

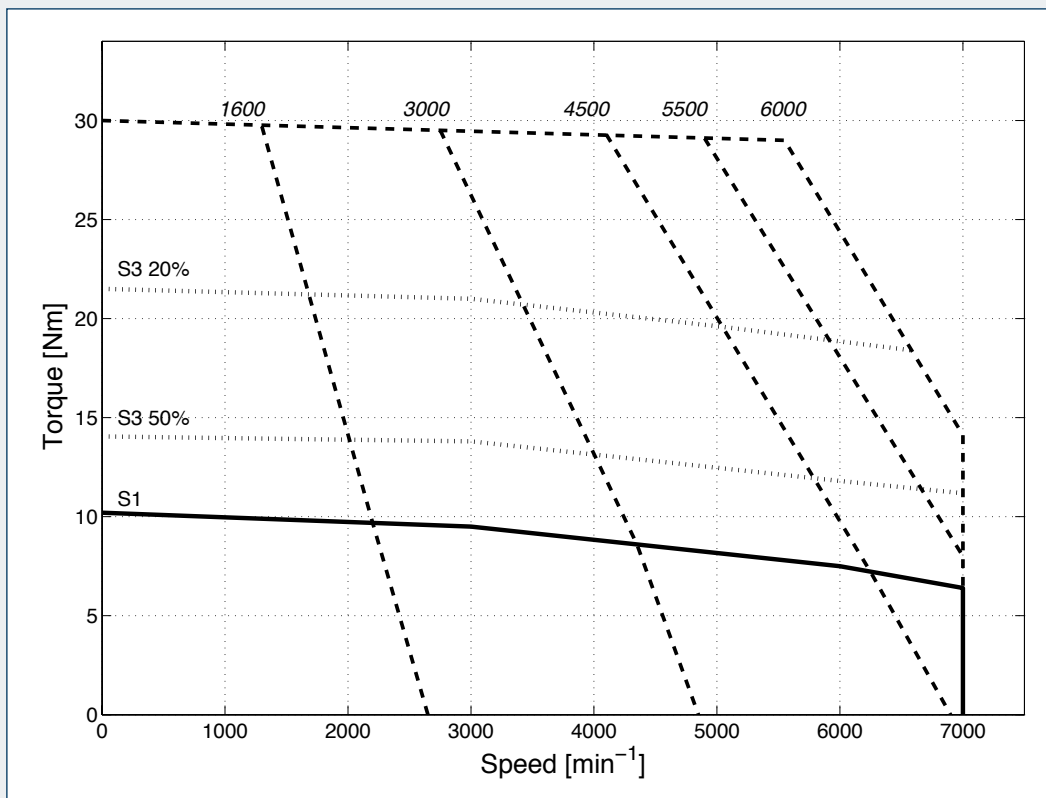

BMD 118 • 14 Nm - 400V

Parameter	Symbol	Unit	Speed [min ⁻¹]				
			1600	3000	4500	5500	6000
Standstill torque (dT=105K)	M ₀	[Nm]	14.0				
Motor rated frequency	f _n	[Hz]	107	200	300	367	400
Motor rated voltage	V _n	[V _{AC}]	323	320	325	335	329
Rated Torque (dT=105K)	M _n	[Nm]	13.3	12.2	10.9	9.7	9.0
Current at rated speed	I _n	[A]	4.9	8.4	10.9	11.4	11.8
Standstill current	I ₀	[A]	5.3	9.8	14.4	16.9	18.9
Max Torque	M _{max}	[Nm]	39	39	39	39	39
Max Current	I _{max}	[A]	17.2	32	47	55	62
Back EMF constant	K _e	[V/1000min ⁻¹]	182	98	67	57	51
Torque constant	K _T	[Nm/A]	2.66	1.43	0.97	0.83	0.74
Rated Power	P _n	[kW]	2.2	3.8	5.0	5.3	5.3
Stator phase-phase Resistance (at 20°C)	R _{pp}	[Ω]	3.60	1.04	0.48	0.35	0.28
Stator phase-phase Inductance	L _{pp}	[mH]	47.4	13.7	6.3	4.6	3.7
Rotor inertia	J _m	[kgm ² × 10 ⁻⁴]	9.9				
Electric time constant (at 20°C)	τ _{el}	[ms]	13				
Thermal time constant	τ _{therm}	[min]	42				
Motor mass without brake	m _M	[kg]	11.7				
Motor mass with brake	m _{MB}	[kg]	12.9				

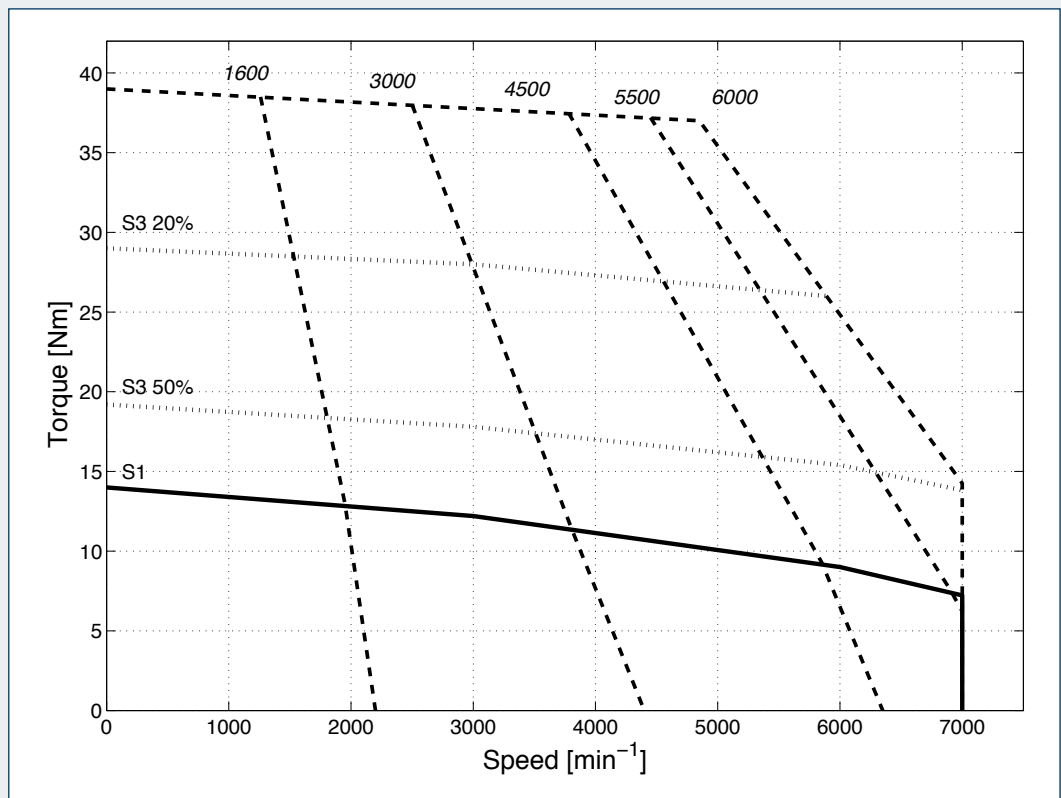

BMD 145 • 16.8 Nm - 400V

Parameter	Symbol	Unit	Speed [min ⁻¹]				
			1600	3000	4500	5500	6000
Standstill torque (dT=105K)	M ₀	[Nm]	16.8				
Motor rated frequency	f _n	[Hz]	107	200	300	367	400
Motor rated voltage	V _n	[V _{AC}]	314	308	314	319	305
Rated Torque (dT=105K)	M _n	[Nm]	16.5	16	14	13	12.5
Current at rated speed	I _n	[A]	6.8	12.5	16.4	17.5	19
Standstill current	I ₀	[A]	6.9	13.0	19.0	22.8	26
Max Torque	M _{max}	[Nm]	46	46	46	46	46
Max Current	I _{max}	[A]	26.7	50	73	88	100
Back EMF constant	K _e	[V/1000min ⁻¹]	156	83	57	47	42
Torque constant	K _T	[Nm/A]	2.42	1.29	0.88	0.74	0.65
Rated Power	P _n	[kW]	2.76	5.0	6.6	7.5	7.9
Stator phase-phase Resistance (at 20°C)	R _{pp}	[Ω]	2.53	0.72	0.34	0.24	0.18
Stator phase-phase Inductance	L _{pp}	[mH]	40.4	11.5	5.4	3.8	2.9
Rotor inertia	J _m	[kgm ² x 10 ⁻⁴]	12.8				
Electric time constant (at 20°C)	τ _{el}	[ms]	16				
Thermal time constant	τ _{therm}	[min]	36				
Motor mass without brake	m _M	[kg]	15.2				
Motor mass with brake	m _{MB}	[kg]	17.8				

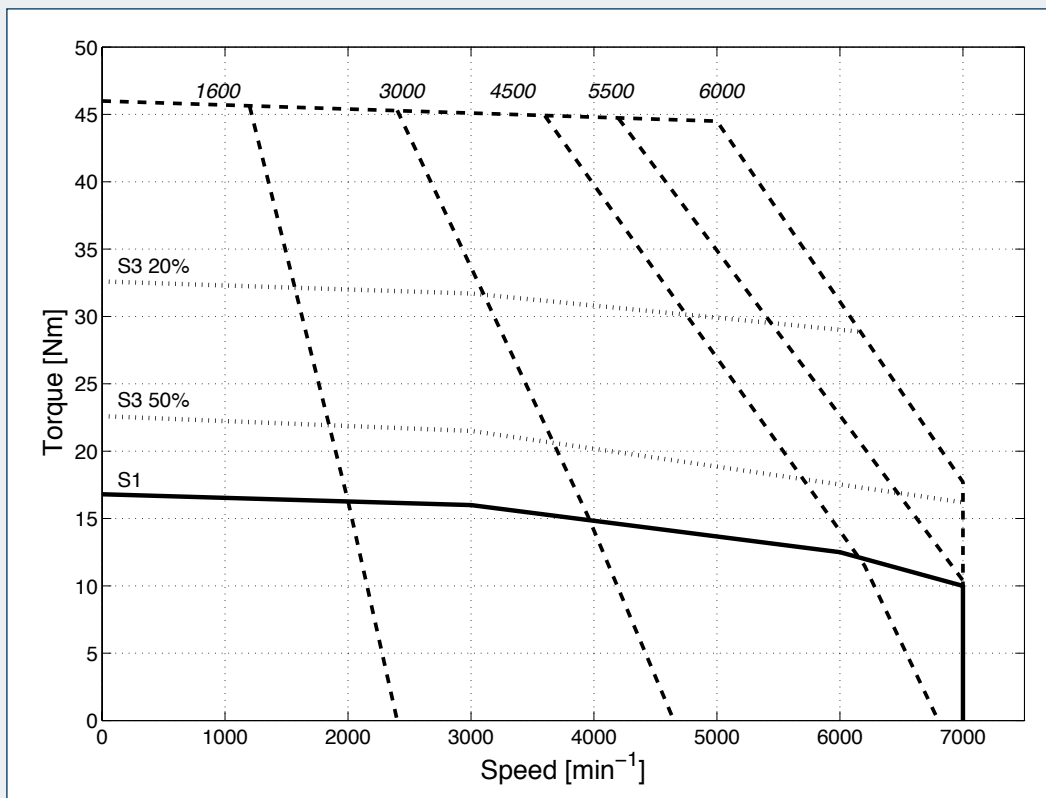

BMD 145 • 22 Nm - 400V

Parameter	Symbol	Unit	Speed [min ⁻¹]			
			1600	3000	4500	5500
Standstill torque (dT=105K)	M_0	[Nm]	22.0			
Motor rated frequency	f_n	[Hz]	107	200	300	367
Motor rated voltage	V_n	[V _{AC}]	319	321	323	357
Rated Torque (dT=105K)	M_n	[Nm]	20.7	19.2	17	15
Current at rated speed	I_n	[A]	8.4	14.2	18.3	17.6
Standstill current	I_0	[A]	9.0	16.4	24.3	26.5
Max Torque	M_{max}	[Nm]	59	59	59	59
Max Current	I_{max}	[A]	29.5	54	80	87
Back EMF constant	K_e	[V/1000min ⁻¹]	176	96	65	59
Torque constant	K_T	[Nm/A]	2.45	1.34	0.90	0.83
Rated Power	P_n	[kW]	3.5	6.0	8.0	8.6
Stator phase-phase Resistance (at 20°C)	R_{pp}	[Ω]	1.97	0.59	0.27	0.23
Stator phase-phase Inductance	L_{pp}	[mH]	31.5	9.4	4.3	3.6
Rotor inertia	J_m	[kgm ² × 10 ⁻⁴]	17.6			
Electric time constant (at 20°C)	τ_{el}	[ms]	16			
Thermal time constant	τ_{therm}	[min]	47			
Motor mass without brake	m_M	[kg]	18.2			
Motor mass with brake	m_{MB}	[kg]	20.8			

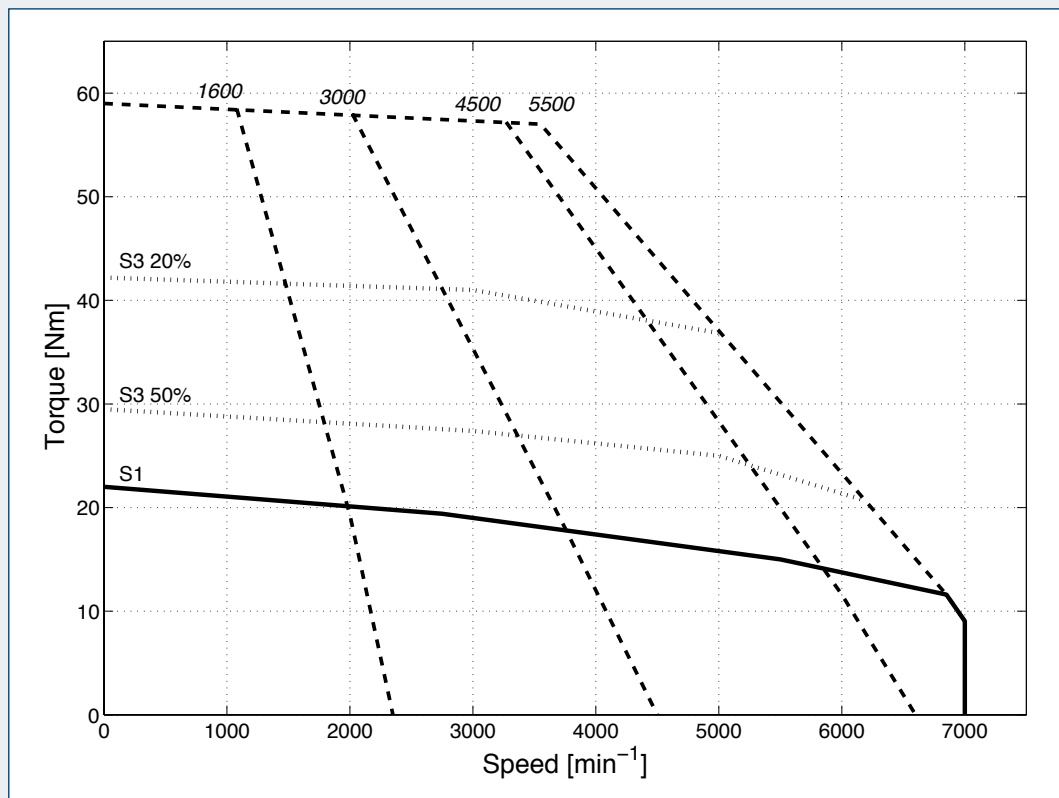

BMD 170 • 34 Nm - 400V

Parameter	Symbol	Unit	Speed [min^{-1}]	
			1600	3000
Standstill torque (dT=105K)	M_0	[Nm]	34.0	
Motor rated frequency	f_n	[Hz]	107	200
Motor rated voltage	V_n	[V _{AC}]	319	315
Rated Torque (dT=105K)	M_n	[Nm]	31	27.5
Current at rated speed	I_n	[A]	11.2	18.6
Standstill current	I_0	[A]	12.4	23.3
Max Torque	M_{max}	[Nm]	90	90
Max Current	I_{max}	[A]	37	70
Back EMF constant	K_e	[V/1000 min^{-1}]	174	93
Torque constant	K_T	[Nm/A]	2.74	1.46
Rated Power	P_n	[kW]	5.2	8.6
Stator phase-phase Resistance (at 20°C)	R_{pp}	[Ω]	0.91	0.26
Stator phase-phase Inductance	L_{pp}	[mH]	17.9	5.1
Rotor inertia	J_m	[$\text{kgm}^2 \times 10^{-4}$]	28.2	
Electric time constant (at 20°C)	τ_{el}	[ms]	20	
Thermal time constant	τ_{therm}	[min]	50	
Motor mass without brake	m_M	[kg]	25	
Motor mass with brake	m_{MB}	[kg]	29.5	

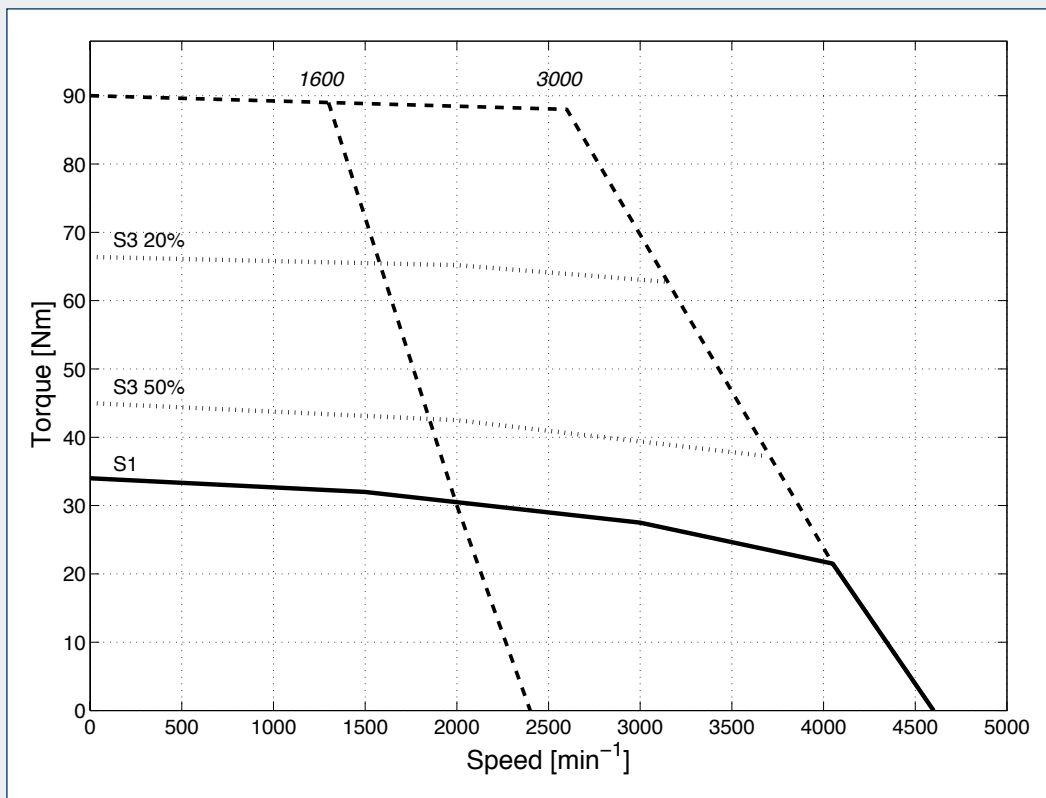

BMD 170 • 45 Nm - 400V

Parameter	Symbol	Unit	Speed [min ⁻¹]	
			1600	3000
Standstill torque (dT=105K)	M ₀	[Nm]	45.0	
Motor rated frequency	f _n	[Hz]	107	200
Motor rated voltage	V _n	[V _{AC}]	310	314
Rated Torque (dT=105K)	M _n	[Nm]	42	36
Current at rated speed	I _n	[A]	15.9	24.9
Standstill current	I ₀	[A]	17.1	31
Max Torque	M _{max}	[Nm]	125	125
Max Current	I _{max}	[A]	52	96
Back EMF constant	K _e	[V/1000min ⁻¹]	185	101
Torque constant	K _T	[Nm/A]	2.74	1.50
Rated Power	P _n	[kW]	7.0	11.3
Stator phase-phase Resistance (at 20°C)	R _{pp}	[Ω]	0.57	0.17
Stator phase-phase Inductance	L _{pp}	[mH]	11.1	3.3
Rotor inertia	J _m	[kgm ² x 10 ⁻⁴]	47.5	
Electric time constant (at 20°C)	τ _{el}	[ms]	19	
Thermal time constant	τ _{therm}	[min]	65	
Motor mass without brake	m _M	[kg]	30	
Motor mass with brake	m _{MB}	[kg]	34.5	

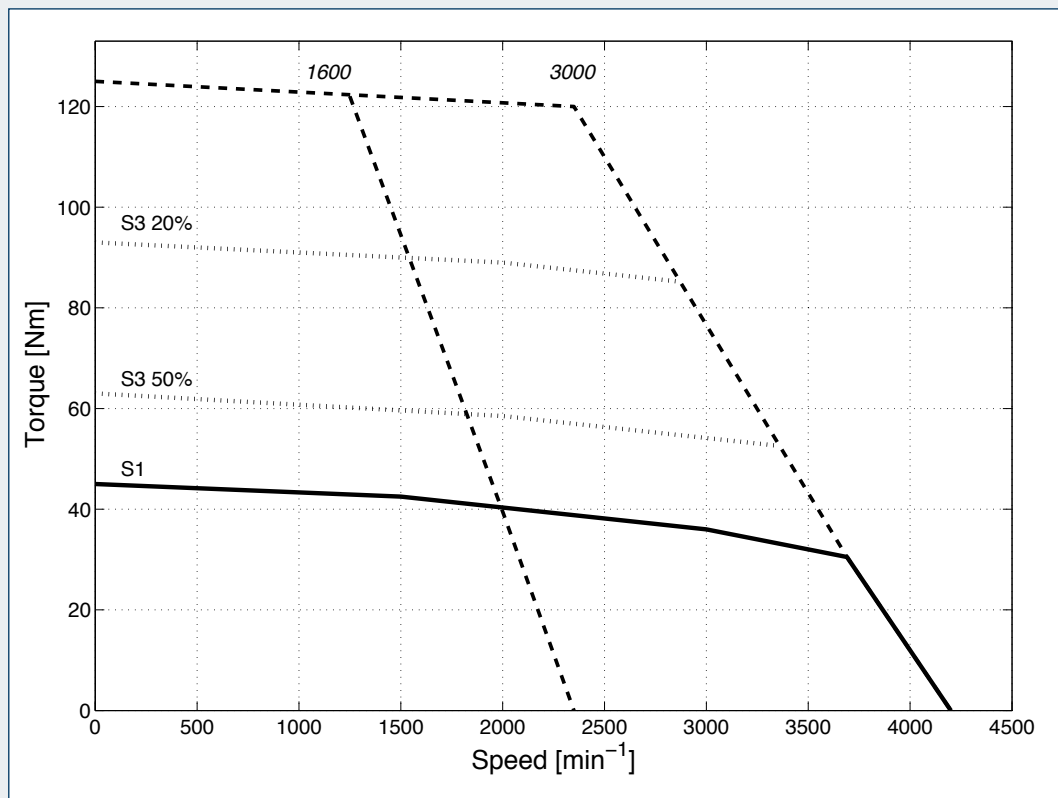

Dimensions (from BMD 65 to BMD 102)

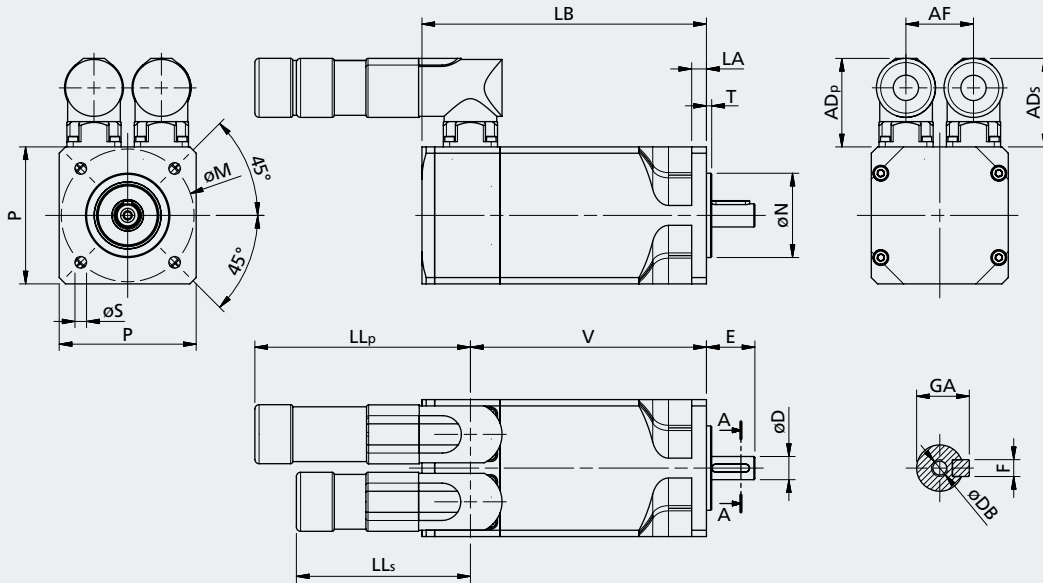

Type	Shaft				
	D	E	DB	GA ⁽¹⁾	F ⁽¹⁾
65	9	20	M3	10.2	3
	11	23	M4	12.5	4
82	11	23	M4	12.5	4
	14	30	M5	16	5
	19	40	M6	21.5	6
102	19	40	M6	21.5	6
	24	50	M8	27	8

Type	Flange					
	M	N	P	S	T	LA
65	63	40	65	5.5	2.5	7
	75	60	65	6	2.5	7
82	100	80	82	6.5	3	10
	115	95	100	9	3	10
102	100	80	102	7	3	10
	115	95	102	9	3	10

Type	Motor																
	T ₀	AC	LB ₂	LB ₃	LB ₄	LB ₅	LB ₆	LB ₇	ADp	ADs	AF	LLp	LLs	V ₈	V ₉	V ₁₀	V ₁₁
65	0.85	65	112	143	130	130	179	179	41.5	41.5	32	96	96	89	89	138	138
	1.7		135	166	153	153	202	202						112	112	161	161
	2.2		161	192	179	179	228	228						138	138	187	187
82	3.2	82	160	200	183	160	223	223	41.5	41.5	36	96	96	132	132	195	195
	4.4		180	220	203	180	243	243						152	152	215	215
102	7.2	102	180	220	203	180	243	220	41.5	41.5	39	96	96	150	150	190	190
	9.6		207	247	230	207	297	247						177	177	217	217

Notes:

- (1) Motor shaft extension without key available.
- LB₂ Motor length with resolver, or in sensorless version.
- LB₃ Motor length with resolver, or in sensorless version, and with brake or flywheel.
- LB₄ Motor length with encoder EnDat (ENB1, ENB2).
- LB₅ Motor length with encoder Hiperface (ENB3, ENB4).
- LB₆ Motor length with encoder EnDat (ENB1, ENB2) and with brake or flywheel.
- LB₇ Motor length with encoder Hiperface (ENB3, ENB4) and with brake or flywheel.
- V₈ Motor with resolver, encoder (ENB1, ENB2, ENB3, ENB4) or in sensorless version.
- V₉ Motor with resolver, or in sensorless version and with brake or flywheel.
- V₁₀ Motor with encoder EnDat (ENB1, ENB2) and with brake or flywheel.
- V₁₁ Motor with encoder Hiperface (ENB3, ENB4) and with brake or flywheel.

Dimensions (from BMD 118 to BMD 170)

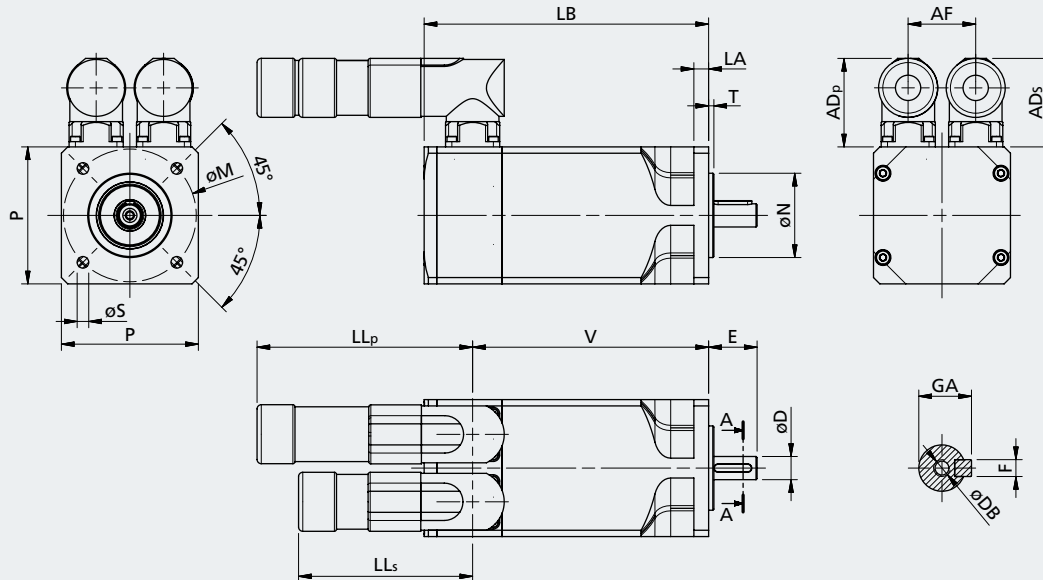

Type	Shaft				
	D	E	DB	GA ⁽¹⁾	F ⁽¹⁾
118	19	40	M6	21.5	6
	24	50	M8	27	8
	28	60	M10	31	8
145	19	40	M6	21.5	6
	24	50	M8	27	8
	28	60	M10	31	8
170	24	50	M8	27	8
	28	60	M10	31	8
	32	60	M12	35	10

Type	Flange					
	M	N	P	S	T	LA
118	130 ⁽²⁾	95	118	9	3.5	10
	130	110	118	9	3.5	10
	165	130	145	11.5	3.5	10
145	165	130	145	11.5	3.5	12
170	165	130	170	11.5	3.5	12

Type	Motor																
	T ₀	AC	LB ₂	LB ₃	LB ₄	LB ₅	LB ₆	LB ₇	ADp	ADs	AF	LLp	LLs	V ₈	V ₉	V ₁₀	V ₁₁
118	10.2	118	210	260	235	210	285	260	41.5	41.5	96	96	96	175	225	225	225
	14		243	293	268	243	351	293						208	258	258	258
145	16.8	145	230	280	255	230	305	280	41.5	41.5	96	96	96	195	245	245	245
	22		265	315	290	265	375	315						230	280	280	280
170	34	170	265	340	303	265	378	340	41.5	41.5	140	96	96	233	308	308	308
	45		319	394	357	319	432	394						287	362	362	362

Notes:

(1) Motor shaft extension without key available.

(2) Mechanical interface 130S.

LB₂ Motor length with resolver, or in sensorless version.

LB₃ Motor length with resolver, or in sensorless version, and with brake or flywheel.

LB₄ Motor length with encoder EnDat (ENB1, ENB2).

LB₅ Motor length with encoder Hiperface (ENB3, ENB4).

LB₆ Motor length with encoder EnDat (ENB1, ENB2) and with brake or flywheel

LB₇ Motor length with encoder Hiperface (ENB3, ENB4) and with brake or flywheel

V₈ Motor with resolver, encoder (ENB1, ENB2, ENB3, ENB4) or in sensorless version.

V₉ Motor with resolver, or in sensorless version and with brake or flywheel.

V₁₀ Motor with encoder EnDat (ENB1, ENB2) and with brake or flywheel

V₁₁ Motor with encoder Hiperface (ENB3, ENB4) and with brake or flywheel

Feedback devices

Bonfiglioli BMD servomotor series is available with different feedback devices. Available feedbacks are resolver and optical absolute encoders, single turn or multi turn. All available feedback devices are managed by the Bonfiglioli Vectron frequency inverter of ACTIVE CUBE series. Dedicated feedback interfaces are available.

The resolver is a passive wound device consisting of a stator and rotor elements excited from an external source. It produces two output signals that correspond to the sine and cosine angle of the motor shaft. This is a robust absolute device of good accuracy, capable of withstanding high temperature and high levels of vibration. Positional information is absolute within one turn.

The optical absolute encoder uses a high precision optical disc. The high resolution performed is based on a combination of absolute information, transmitted via a serial link, and sine/cosine signals with incremental techniques. Single turn absolute encoder has an absolute positional information only within one turn.

Multi turn absolute encoder is provided of extra gear wheels that account for several shaft revolution. Therefore the output is unique for each shaft position and revolution up to available revolutions.

Resolver datasheet

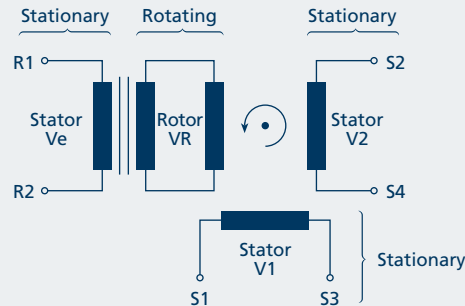

Item	BMD 65		BMD82 - BMD170	
	RES2	RES1	RES1	RES2
Poles number	2	2	2	2
Transformation ratio	0.5 ±5%	0.5 ^{+15%} _{-5%}	0.5 ^{+15%} _{-5%}	0.5 ±5%
Input voltage [Vac _{rms}]	7	11	11	5.5
Input current [mA]	65	57	57	61
Input frequency [kHz]	10	8	8	10
Phase shift	0°	-11°	-11°	-12°
Input impedance Z _{ro} ()	70 + j100	75 + j185	75 + j185	43 + j79
Output impedance Z _{ss} (Ω)	175 + j275	135 + j265	135 + j265	62 + j112
Electrical error	±10'	±10'	±10'	±10'
Accuracy ripple	1' max	1' max	1' max	1' max
Operating temperature	-55°C ... + 155°C	-55°C ... + 155°C	-55°C ... + 155°C	-55°C ... + 155°C
Max Speed [min ⁻¹]	10000	20000	20000	10000
Mass [kg]	0.065	0.28	0.28	0.28
Rotor Inertia [kgm ² x 10 ⁻⁶]	3.0	5.0	5.0	5.0

Encoder datasheet

HEIDENHAIN ENCODERS

Item	BMD 65		BMD82 - BMD170	
	ENB1	ENB2	ENB1	ENB2
Data interface	EnDat		EnDat	
Model	ECN1113	EQN1125	ECN1313	EQN1325
Type	Single turn	Multi turn	Single turn	Multi turn
Power supply	3.6VDC ... 14VDC	3.6VDC ... 14VDC	3.6VDC ... 14VDC	3.6VDC ... 14VDC
Current consumption	85mA (5V)	105mA (5V)	85mA (5V)	105mA (5V)
Periods per revolution	512	512	2048	2048
Position per revolution	8192 (13 bits)	8192 (13 bits)	8192 (13 bits)	8192 (13 bits)
Revolutions	-	4096 (12 bits)	-	4096 (12 bits)
Operating temperature	-40°C ... +115°C		-40°C ... +115°C	
Max Speed [min ⁻¹]	12000		12000	
Mass [kg]	0.10		0.25	
Rotor Inertia [kgm ² x 10 ⁻⁶]	0.40		2.60	

SICK ENCODERS

Item	BMD 65		BMD82 - BMD170	
	ENB3	ENB4	ENB3	ENB4
Data interface	Hiperface		Hiperface	
Model	SKS36	SKM36	SRS50	SRM50
Type	Single turn	Multi turn	Single turn	Multi turn
Power supply	7VDC ... 12VDC	7VDC ... 12VDC	7VDC ... 12VDC	7VDC ... 12VDC
Current consumption	60mA	60mA	80mA	80mA
Periods per revolution	128	128	1024	1024
Position per revolution	4096 (12 bits)	4096 (12 bits)	32768 (15 bit)	32768 (15 bit)
Revolutions	-	4096 (12 bits)	-	4096 (12 bits)
Operating temperature	-30°C ... +110°C		-20°C ... +110°C	
Max Speed [min ⁻¹]	10000		12000	
Mass [kg]	0.07		0.20	
Rotor Inertia [kgm ² x 10 ⁻⁶]	0.45		1.00	

PTC/KTY thermal protection

All motors in the BMD Series are equipped with an integrated PTC temperature as standard to protect the windings against overtemperatures exceeding the limit of the motor class F insulation.

These sensors are in conformity to standard DIN 44081-82.

Optionally a KTY sensor is available, to fit any needs for temperature feedback.

The PTC temperature sensor consists of a special ceramic resistor whose ohmic value varies with the temperature of the electrical winding with which it is held on close contact. Each temperature value generates a known resistance, so that provided the resistor is fed at a constant voltage, the output current can be used to determine the corresponding temperature. If temperature

reaches an established limit, the circuit monitoring the signal trips the necessary cutout to disconnect power to the motor and prevent damage.

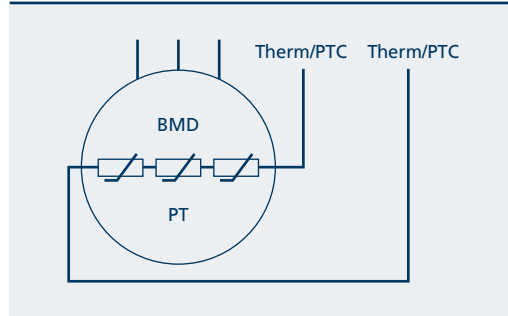

A triple PTC thermistor rated to 150°C is placed into the motor winding. The resistance curve of the PTC thermistor is in accordance with DIN 44081-82.

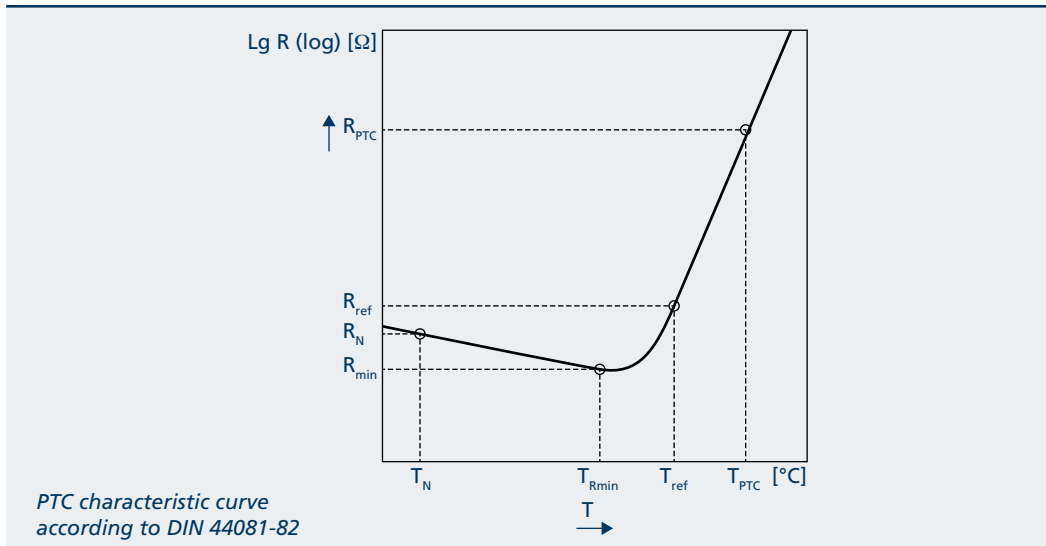

KTY 84-130

KTY 84-130 silicon sensors are optionally available. Working temperature range: -40°C ÷ +260°C.

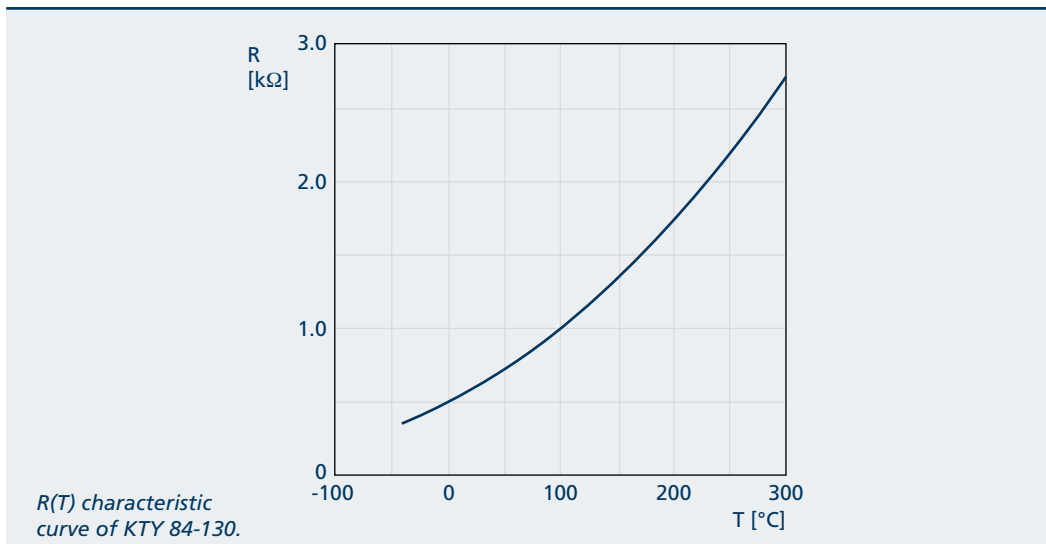

Electromechanical holding brake

An electromagnetic holding brake is available. The brake variant can be ordered by selecting the F24 value in the brake option field.

The electromechanical brake is for use as an holding brake with motor shaft stationary. Do not use it as a dynamic brake, except for emergencies such as main supply failure.

Data of the available brake for each motor size are summarized in the following table. When the motor is delivered without brake, the brake fitting is not possible.

The brake coil voltage supply must be 24V DC-voltage.

The brake option is responsible of an increment of the motor length (see in pages 42-43). Brake leads are wired in the power connector together with motor leads.

Please note that the brake option is not available when the "additional inertia" option is selected.

Motor	Motor stall torque	Rated brake torque 20°C M_b	Rated brake torque 100°C M_b	Brake voltage V_b	Brake current I_b	Brake power 20°C P_b	Brake inertia	Mass m_b	Engaging time t_1	Release time t_2
	Nm	Nm	Nm	Vdc	A	W	Kgm ² x10 ⁻⁴	kg	ms	ms
65	0.85	2	1.8	24	0.46	11	0.068	0.15	6	25
	1.7									
	2.2									
82	3.2	4.5	4		0.5	12	0.18	0.35	7	35
	4.4									
102	7.2	9	8		0.75	18	0.54	0.7	7	40
	9.6									
118	10.2	18	15		1.0	24	1.66	1.1	10	50
	14									
145	16.8	18	15		1.0	24	1.66	1.1	10	50
	22									
170	34	36	32	1.1	26	5.56	1.8	22	90	
	45									

Note

t_1 Time from disconnecting the current until the rated torque is attained

t_2 Time from connecting the current until the torque decreases

Power connections

The motor connections can be made by connectors (P1N,P1, S1N, S1 options) or by cables (P2, S2 options).

and the ones for the brake supply (if provided). The 8-pin power connector of the sensorless motor has also the pins for the thermal protection (PTC or KTY). Same layouts are used for motor with flying cable connection.

Power connections

The 6-pin power connector of the motor with feedback includes the pins of the motor supply

MOTOR WITH FEEDBACK DEVICE / BMD65 - BMD145		
Power connector layout (P1N/P1 options)		Power cable (P2 option)
Connector PIN number	Description	Cable label or color
1	Phase U	L1 / 1 / U
2	Phase V	L2 / 2 / V
$\frac{\perp}{\text{E}}$	Earth - SL	Yellow - Green
4	Brake +	White
5	Brake -	Black
6	Phase W	L3 / 3 / W

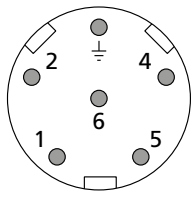

MOTOR WITH FEEDBACK DEVICE / BMD170		
Power connector layout (P1N/P1 options)		Power cable (P2 option)
Connector PIN number	Description	Cable label or color
U	Phase U	L1 / 1 / U
V	Phase V	L2 / 2 / V
W	Phase W	L3 / 3 / W
$\frac{\perp}{\text{E}}$	Earth - SL	Yellow - Green
+	Brake +	White
-	Brake -	Black

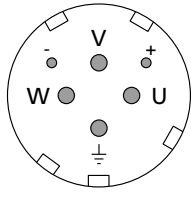

SENSORLESS MOTOR / BMD65 - BMD145		
Power connector layout (P1N/P1 options)		Power cable (P2 option)
Connector PIN number	Description	Cable label or color
1	Phase U	L1 / 1 / U
$\frac{\perp}{\text{E}}$	Earth - SL	Yellow - Green
3	Phase W	L3 / 3 / W
4	Phase V	L2 / 2 / V
A	Ptc / Kty +	White / 5
B	Ptc / Kty -	Black / 6
C	Brake +	7
D	Brake -	8

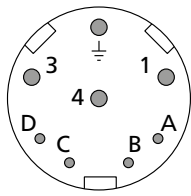

SENSORLESS MOTOR / BMD170		
Power connector layout (P1N/P1 options)		Power cable (P2 option)
Connector PIN number	Description	Cable label or color
U	Phase U	L1 / 1 / U
V	Phase V	L2 / 2 / V
W	Phase W	L3 / 3 / W
$\frac{\perp}{\text{E}}$	Earth - SL	Yellow - Green
1	Ptc / Kty +	White / 5
2	Ptc / Kty -	Black / 6
+	Brake +	7
-	Brake -	8

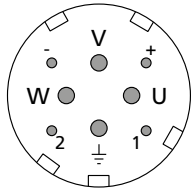

Signal connections

The signal connections are used to link the motor feedback with the inverter feedback module. The thermal protection leads (from PTC or KTY) are included in the signal connector and cable. Different connector layouts are defined for each feedback device.

Variants with flying signal cable have different termination on the inverter feedback module side. S2 variant has lead wires with ferrules for connection to screw terminals. S2C variant has SUB-D male standard connector with layout in accordance with the Bonfiglioli interface module.

MOTOR WITH RESOLVER (RES1/RES2) / BMD65 - BMD170		
Signal connector layout (S1N/S1 options)		Signal cable (S2 option)
Connector PIN number	Description	Cable color
1	Sin -	Brown
2	Sin +	Green
3	not connected	not connected
4	Shield cable	-
5	not connected	not connected
6	not connected	not connected
7	Exct -	Black
8	Ptc / Kty -	White (0.50 mm ²)
9	Ptc / Kty +	Brown (0.50 mm ²)
10	Exct +	Red
11	Cos +	Gray
12	Cos -	Rose

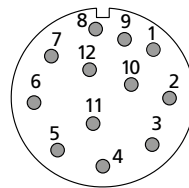

MOTOR WITH ENDAT ENCODER (ENB1/ENB2) / BMD65 - BMD170		
Signal connector layout (S1N/S1 options)		Signal cable (S2 option)
Connector PIN number	Description	Cable color
1	UP SENSOR	Violet
2	not connected	not connected
3	not connected	not connected
4	0V SENSOR	Yellow
5	Ptc / Kty -	Blue
6	Ptc / Kty +	White
7	UP	White Green
8	Clock +	Blue
9	Clock -	Black
10	0V	Brown Green
11	Shield cable	-
12	B +	Red Black
13	B -	Green Black
14	DATA +	Gray
15	A +	Blue Black
16	A -	Yellow Black
17	DATA -	Rose

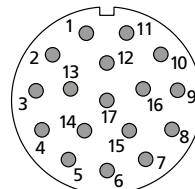

MOTOR WITH HYPERFACE ENCODER (ENB3/ENB4) / BMD65 - BMD170		
Signal connector layout (S1N/S1 options)		Signal cable (S2 option)
Connector PIN number	Description	Cable color
1	Sin +	Green
2	Sin -	Brown
3	RS485 +	Blue
4	not connected	not connected
5	Shield cable	-
6	not connected	not connected
7	GND (0V)	Black
8	Ptc / Kty -	White (0.50 mm ²)
9	Ptc / Kty +	Brown (0.50 mm ²)
10	+ Vdc	Red
11	Cos +	Gray
12	Cos -	Rose
13	RS485 -	Violet
14	not connected	not connected
15	not connected	not connected
16	not connected	not connected
17	not connected	not connected

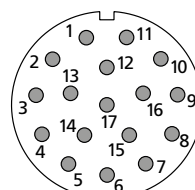

Additional inertia feature

BMD Permanent Magnet AC Synchronous Motor series is provided optionally with additional inertia. The BMD motors with additional inertia have higher rotor moment of inertia in comparison with basic version.

Additional inertia is designed to be used in application with high load inertia. The increased rotor moment of inertia provides a comfortable control response due to "higher" inertial matching of the machine.

Motor	Motor stall torque	Additional inertia	Additional weight
	Nm		
65	0.85	0.5	0.3
	1.7		
	2.2		
82	3.2	3	0.7
	4.4		
102	7.2	7.5	1.3
	9.6		
118	10.2	16	2.4
	14		
145	16.8	36	3.6
	22		
170	34	70	5.5
	45		

Servocables

The word servocable is referred to electrical cable connecting Bonfiglioli servomotor to respective inverter.

A servocables selection is available for power supply and sensor feed-back, justifying the distinction between power cables and signal cables.

The power cable provides energy to motor, but also feeds the brake when present.

The signal cables instead are in charge of transmission of electrical signals generated by feed-back equipment installed on the motor. The same cable is also used to convey the PTC signals. All servocables are available in three different and fixed lengths (3 meters, 5 m, 10 m) offering to user an exhaustive proposal to numerous needs of configuration.

Other lengths available on request.

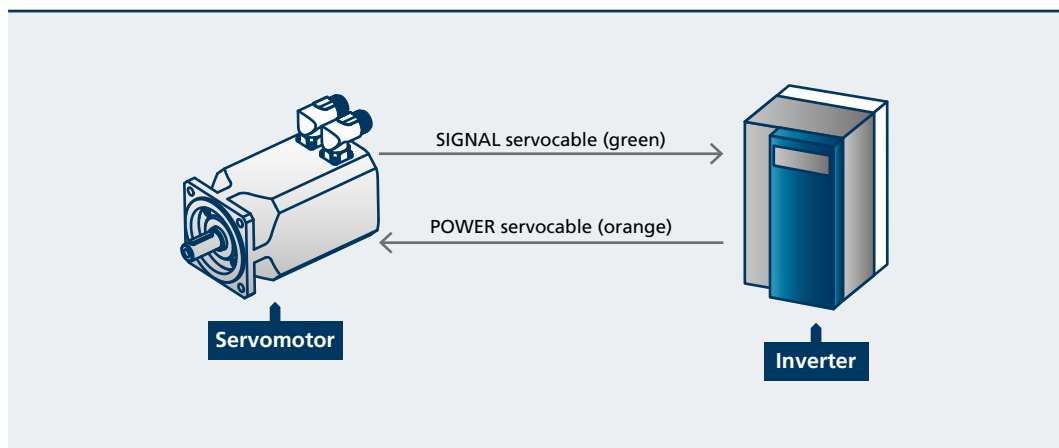

Servocables

Power servocables

Power cables are recognized by the orange color according to Desina standard. The conductors cross-section depends on the motor nominal current. In order to face different current level absorbed by different motor sizes, the power cables are executed with four conductors cross sections (1.5 mm², 2.5 mm², 4.0 mm², 10.0 mm²). On inverter side, every cable terminates with

flying leads covered by ferrules for plug-in into screw terminals. On motor side the cable is equipped with metal circular plug with Speed-Tech technology for easy and sure plug-in with corresponding motor rotatable receptacle. According to page 48, power connectors have 6 pins for motor with feedback and 8 pins for sensorless motor variants.



Inverter side

Motor side

The power cables fulfil the following technical requirements:

Technical Data	
Properties	Oil resistant shielded cable for dynamic laying
Conductor	Tinned Stranded Cu wire complying with IEC 60228 Cl 5 / 6
Outer Sheath	PUR or equivalent thermoplastic material - Color: orange RAL 2003
Inner Sheath	PP or TPE
Tinned Cu braid Shield	Coverage overall screen > 80%

Electrical Data	
Nom. Volt. Power cores	U ₀ /U 600/1000V
Nom. Volt. Control cores	U ₀ /U 300/500V
AC Test Volt. Power cores	4 kV
AC Test Volt. Control cores	1 kV
Insulation Resistance	> 5 MOhm/km

Mechanical Data	
Service Temperature	-15 / +80 °C
Minimum Bending Radius	10 x D
N° bending cycles	≥ 10 ⁶
Max Speed	≥ 180 m/min
Max Acceleration	≥ 15 m/s ²

Standard and Certifications
UL/CSA, RoHS, DESINA

The cable ordering code is structured in the following mode with five fields:

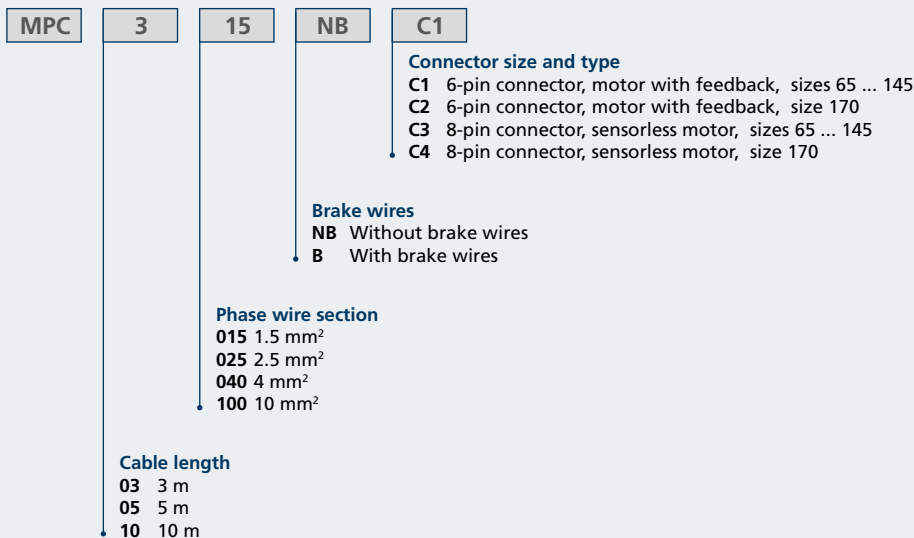

Power servocables

For helping the user during servomotor-cable selection, the following matching tables are proposed. Field XX refers to the cable length (03,

05, 10), while field YY refers to the brake variant (NB, B): see previous page for fields description.

Size	Stall torque		Nominal speed				
	Nm		1600 min ⁻¹	3000 min ⁻¹	4500 min ⁻¹	5500 min ⁻¹	6000 min ⁻¹
400V NOMINAL VOLTAGE – MOTOR WITH FEEDBACK							
65	0.85						
	1.7						
82	2.2						
	3.2						
102	4.4				MPC XX 015 YY C1		
	7.2						
118	9.6						
	10.2						
145	14				MPC XX 025 YY C1		
	16.8						
170	22				MPC XX 040 YY C1		
	34	MPC XX 040 YY C2					
170	45		MPC XX 100 YY C2				Not available
400V NOMINAL VOLTAGE – SENSORLESS MOTOR WITH CONNECTOR							
65	0.85						
	1.7						
82	2.2						
	3.2						
102	4.4						
	7.2						
118	9.6						
	10.2						
145	14						
	16.8						
170	22						
	34	MPC XX 040 YY C4					
170	45		MPC XX 100 YY C4				Not available
230V NOMINAL VOLTAGE – MOTOR WITH FEEDBACK							
65	0.85						
	1.7						
82	2.2						
	3.2						
102	4.4						
	7.2						
118	9.6						
	10.2						
145	14						
	16.8						
170	22	MPC XX 025 YY C1					
	34	MPC XX 040 YY C1					Not available
170	45	MPC XX 040 YY C2	MPC XX 100 YY C2				
230V NOMINAL VOLTAGE – SENSORLESS MOTOR WITH CONNECTOR							
65	0.85						
	1.7						
82	2.2						
	3.2						
102	4.4						
	7.2						
118	9.6						
	10.2						
145	14						
	16.8						
170	22	MPC XX 025 YY C3					
	34	MPC XX 040 YY C3					Not available
170	45	MPC XX 040 YY C4	MPC XX 100 YY C4				

Signal servocables

Signal cables are recognized by the green color according to Desina standard. The conductors number, their cross-section and their terminal type depend by the transducer typology supported by the cable. Cables are available for connection of every feedback option, either resolver and absolute encoders. On motor side, the cable is equipped with metal circular plug with Speed-Tech technology for an easy and sure plug-in with respective rotatable receptacle present on motor.

On inverter side the cable end can be executed with two different terminations:

- with SUB-D male standard connector for easy and sure plug-in with corresponding SUB-D female of the module interface.
- with ferrules for connection to screw terminals of the module interface.

Connections layouts are dedicated to Bonfiglioli Vectron Active Cube interface modules.



Inverter side

Motor side

The signal cables fulfil the following technical requirements:

Technical Data	
Properties	Oil resistant shielded cable for dynamic laying
Conductor	Tinned Stranded Cu wire complying with IEC 60228 Cl 5 / 6
Outer Sheath	PUR or equivalent thermoplastic material - Color: green RAL 6018
Inner Sheath	PP or TPE
Tinned Cu braid Shield	Coverage overall screen > 80%

Electrical Data	
Nominal Voltage	30 V
AC Test Voltage	1500 V
Insulation Resistance	> 10 MOhm/km
Capacitance strand/strand	< 150 pF/m

Mechanical Data	
Service Temperature	-20 / +80 °C
Minimum Bending Radius	10 x D
N° bending cycles	≥ 10 ⁶
Max Speed	≥ 180 m/min
Max Acceleration	≥ 15 m/s ²

Standard and Certifications
UL/CSA, RoHS, DESINA

The ordering codes of the signal cables are described in the following table:

Feedback device	Inverter side termination	Inverter feedback module	Cable length		
			3 m	5m	10 m
RES1 / RES2	Flying leads	EM-RES-01/02	MSC 03 RES FW	MSC 05 RES FW	MSC 10 RES FW
	SUB-D9	EM-RES-03	MSC 03 RES SC	MSC 05 RES SC	MSC 10 RES SC
ENB1 / ENB2	HD SUB-D15	EM-ABS-01	MSC 03 EN1 SC	MSC 05 EN1 SC	MSC 10 EN1 SC
	Flying leads	-	MSC 03 EN1 FW	MSC 05 EN1 FW	MSC 10 EN1 FW
ENB3 / ENB4	SUB-D15	EM-ABS-01	MSC 03 EN3 SC	MSC 05 EN3 SC	MSC 10 EN3 SC
	Flying leads	-	MSC 03 EN3 FW	MSC 05 EN3 FW	MSC 10 EN3 FW

Power cable layout

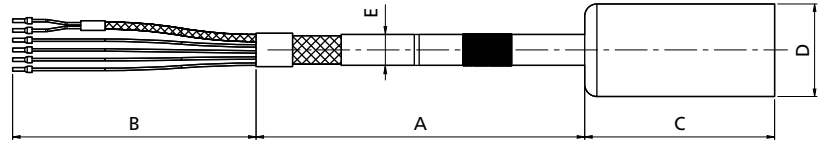

Signal cable layout

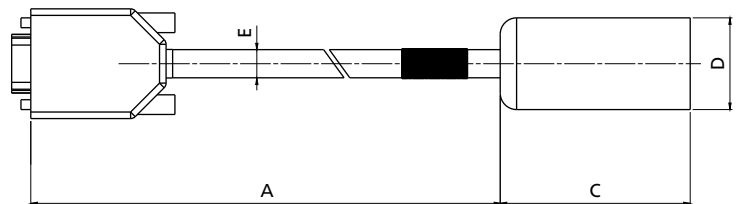
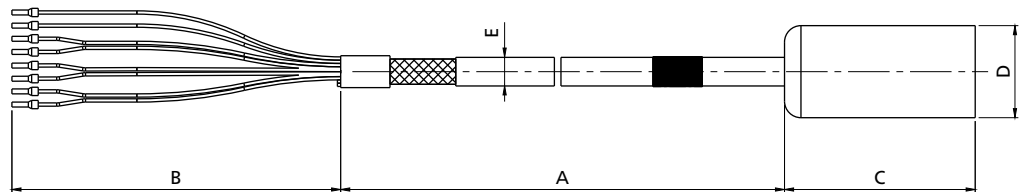

Connector size		A	B	C	D
		[m]	[mm]	[mm]	[mm]
Power Cable	C1 / C3	3 - 5 - 10 according to designation	150	76	28
	C2 / C4			93	46
Signal Cable	-	3 - 5 - 10 according to designation	150	76	28

	Wire section	Brake option	E_{max}
	[mm ²]		[mm]
Power Cable	1.5	NB	11.6
		B	12.8
	2.5	NB	13
		B	14.2
	4	NB	14.7
		B	16.3
10	NB	19.7	
	B	21.8	

	Feedback designation	E
		[mm]
Signal Cable	RES	8.6
	EN1	8.7
	EN3	8.6

Power and signal cable marking follows the label and wire colors reported in the pages 48 and 49.

Servo gearheads

Motion application requires the use of precision planetary gearboxes to adapt speeds and torques, while ensuring the precision demanded by the application.

Bonfiglioli Riduttori has chosen to use planetary gearboxes with the BMD range of servo motors. Bonfiglioli precision planetary gearboxes (PPG) match with BMD Permanent Magnet synchronous motors and provide industrial motion control equipment with torque multiplication and proper inertial matching.

These gearheads combined with powerful drive electronics are designed for servo applications requiring highest standards in terms of dynamics, precision, robustness, durability, and long trouble-free operation.

Low backlash at a competitive price.

The LC Series of planetary gearboxes is characterized by low backlash, silent running and easy motor coupling.

High precision for excellent results.

The MP Series of low backlash planetary gearboxes is characterized by a wide range of mounting configurations, silent running, and superbly easy motor coupling.

Maximum precision for highly dynamic applications.

The TQ Series of precision planetary gearboxes is designed to deliver the highest level of transmission precision. Low backlash combined with a high torsional stiffness guarantees a very performing product, for in high dynamic and reversing applications. The technical design of this gearbox also allows high axial and radial loads on the output shaft.

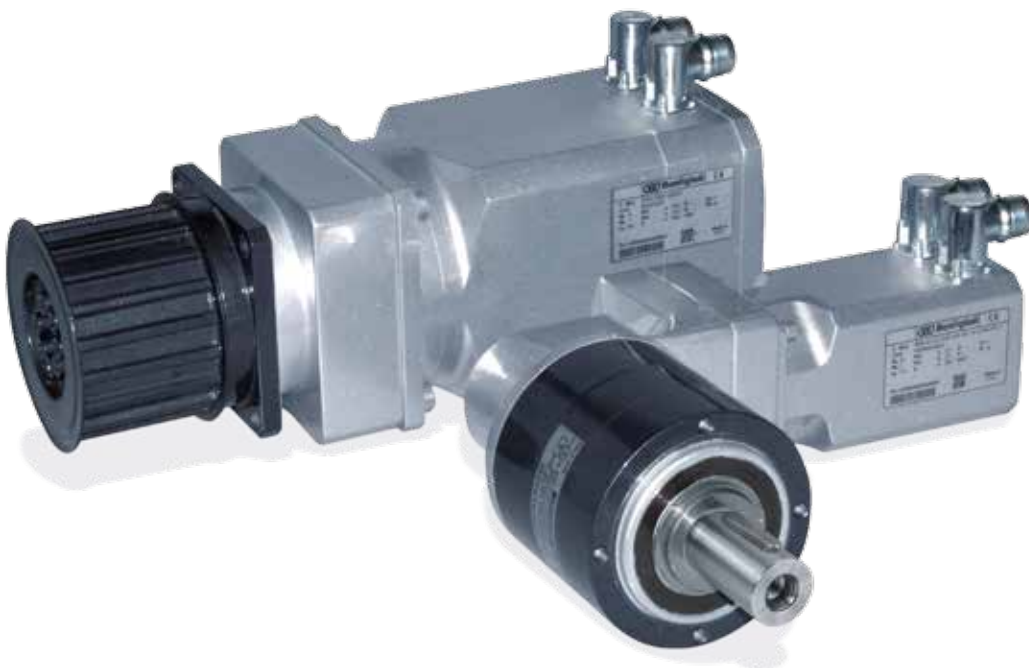

BMD Servomotor / LC series Precision Planetary Gearbox combination

Ratios from 3:1 to 70:1

Type	Motor stall torque [Nm]	Ratios											Motor inertia kgm ² x 10 ⁻³
		3:1	4:1	5:1	7:1	10:1	16:1	20:1	25:1	40:1	50:1	70:1	
BMD 65	0.85		LC 050	LC 050	LC 050	LC 050 LC 070	LC 090	LC 090	LC 090	LC 090 LC 120	LC 090 LC 120	LC 120	0.02
	1.7	LC 050 LC 070	LC 050 LC 070	LC 050 LC 070	LC 070 LC 090	LC 070 LC 090	LC 090	LC 090	LC 090	LC 120	LC 120	LC 120	0.04
	2.2	LC 050 LC 070	LC 050 LC 070	LC 050 LC 070	LC 070 LC 090	LC 090	LC 090	LC 090	LC 120	LC 120	LC 120	LC 120	0.06
BMD 82	3.2	LC 050 LC 070	LC 070 LC 090	LC 070 LC 090	LC 070 LC 090	LC 090 LC 120	LC 120	LC 120	LC 120	LC 155 LC 155	LC 155	LC 155	0.14
	4.4	LC 070 LC 090	LC 070 LC 090	LC 070 LC 090	LC 070 LC 090	LC 120	LC 120	LC 120	LC 120	LC 155	LC 155	LC 155	0.17
BMD 102	7.2	LC 090	LC 090	LC 090 LC 120	LC 120	LC 120 LC 155	LC 155	LC 155	LC 155	LC 155			0.34
	9.6	LC 090	LC 090	LC 090 LC 120	LC 120	LC 155	LC 155	LC 155	LC 155				0.47
BMD 118	10.2	LC 090 LC 120	LC 120	LC 120	LC 120	LC 155	LC 155	LC 155	LC 155				0.9
	14	LC 120	LC 120	LC 120	LC 120	LC 155	LC 155	LC 155					0.99
BMD 145	16.8	LC 120	LC 120	LC 120 LC 155	LC 155	LC 155	LC 155						1.4
	22	LC 120	LC 120	LC 120 LC 155	LC 155	LC 155							1.76
BMD 170	34	LC 155	LC 155	LC 155	LC 155								2.9
	45	LC 155	LC 155	LC 155									4.75

Distribution of gearbox output torque [Nm]

	3	4	5	7	10	16	20	25	40	50	70
LC 050	10	12	12	12	-	12	12	12	-	-	-
LC 070	18	25	25	25	18	25	25	25	25	25	25
LC 090	37	43	43	43	37	43	43	43	43	43	43
LC 120	95	110	110	110	95	110	110	110	110	110	110
LC 155	250	300	300	300	250	300	300	300	300	300	300

Notes:

Input speed lower than 3000 min⁻¹.

Safety factor 1 < S ≤ 4.

For any additional technical information about gearboxes selection see relevant catalogues.

BMD Servomotor / MP series Precision Planetary Gearbox combination

Ratios from 3:1 to 70:1

Type	Motor stall torque [Nm]	Ratios												Motor inertia kgm ² x 10 ⁻³
		3:1	4:1	5:1	6:1	7:1	10:1	16:1	20:1	25:1	40:1	50:1	70:1	
BMD 65	0.85			MP 053	MP 053	MP 053		MP 053	MP 053	MP 060	MP 080	MP 080	MP 080	0.02
	1.7	MP 053 MP 060	MP 053 MP 060	MP 053 MP 060	MP 053 MP 060	MP 053 MP 060	MP 060	MP 060	MP 080	MP 080	MP 080	MP 105	MP 105	0.04
	2.2	MP 053 MP 060	MP 053 MP 060	MP 053 MP 060	MP 053 MP 060	MP 053 MP 060	MP 060	MP 060	MP 080	MP 080	MP 080	MP 105	MP 105	0.06
BMD 82	3.2	MP 053 MP 060	MP 053 MP 060	MP 060 MP 080	MP 060 MP 080	MP 060 MP 080	MP 080	MP 080	MP 080	MP 105	MP 105	MP 105	MP 130	0.14
	4.4	MP 060	MP 060	MP 060 MP 080	MP 060 MP 080	MP 060 MP 080	MP 080	MP 080	MP 080	MP 105	MP 105	MP 105	MP 130	0.17
BMD 102	7.2	MP 080	MP 080	MP 080	MP 080	MP 080	MP 105	MP 105	MP 105	MP 130	MP 130	MP 130	MP 160	0.34
	9.6	MP 080	MP 080	MP 080	MP 105	MP 105	MP 105	MP 105	MP 105	MP 130	MP 130	MP 130	MP 160	0.47
BMD 118	10.2	MP 105	MP 105	MP 105	MP 105	MP 105	MP 130	MP 130	MP 130	MP 130	MP 130	MP 160	MP 190	0.9
	14	MP 105	MP 105	MP 105	MP 105	MP 105	MP 130	MP 130	MP 130	MP 130	MP 130	MP 160	MP 190	0.99
BMD 145	16.8	MP 105	MP 105	MP 105	MP 105	MP 105	MP 130	MP 130	MP 130	MP 160	MP 160	MP 190		1.4
	22	MP 105	MP 105	MP 105	MP 105	MP 130	MP 160	MP 130	MP 130	MP 160	MP 160	MP 190	MP 190	1.76
BMD 170	34	MP 105	MP 105 MP 130	MP 130	MP 130	MP 130	MP 160	MP 160	MP 160	MP 190				2.9
	45	MP 130	MP 130	MP 130	MP 130	MP 130	MP 190	MP 160	MP 160	MP 190				4.75

Distribution of gearbox output torque [Nm]

	3	4	5	6	7	10	16	20	25	40	50	70
MP 053	12	15	15	15	15	-	20	20	20	-	-	-
MP 060	18	25	25	25	25	18	30	30	30	30	30	30
MP 080	40	50	50	50	50	40	70	70	70	70	70	70
MP 105	100	140	140	140	140	100	170	170	170	170	170	170
MP 130	215	380	380	380	380	215	450	450	450	450	450	450
MP 160	350	500	500	500	500	350	700	700	700	700	700	700
MP 190	500	700	700	700	700	500	1000	1000	1000	1000	1000	1000

Notes:

Input speed lower than 3000 min⁻¹.

Safety factor 1 < S ≤ 4.

For any additional technical information about gearboxes selection see relevant catalogues.

BMD Servomotor / TQ series Precision Planetary Gearbox combination

Ratios from 3:1 to 70:1

Type	Motor stall torque	Ratios											Motor inertia
	[Nm]	3:1	4:1	5:1	7:1	10:1	16:1	20:1	25:1	40:1	50:1	70:1	kgm ² x 10 ⁻³
BMD 65	0.85					TQ 060	TQ 060	TQ 060	TQ 060 TQ 070	TQ 070	TQ 070	TQ 070	0.02
	1.7	TQ 060 TQ 070	TQ 060 TQ 070	TQ 060 TQ 070	TQ 060 TQ 070	TQ 060 TQ 070	TQ 060 TQ 070	TQ 070	TQ 070	TQ 070			0.04
	2.2	TQ 060 TQ 070	TQ 060 TQ 070	TQ 060 TQ 070	TQ 060 TQ 070	TQ 070	TQ 070	TQ 070	TQ 070				0.06
BMD 82	3.2	TQ 070	TQ 070	TQ 070	TQ 070	TQ 090	TQ 070	TQ 070	TQ 090	TQ 090	TQ 090		0.14
	4.4	TQ 070	TQ 070	TQ 070	TQ 070	TQ 090	TQ 090	TQ 090	TQ 090	TQ 090			0.17
BMD 102	7.2	TQ 070	TQ 090	TQ 090 TQ 090	TQ 070 TQ 090	TQ 090	TQ 090	TQ 090	TQ 090	TQ 090			0.34
	9.6	TQ 070	TQ 090	TQ 090 TQ 090	TQ 070 TQ 090	TQ 090	TQ 090	TQ 130	TQ 130	TQ 130			0.47
BMD 118	10.2	TQ 070 TQ 090	TQ 070 TQ 090	TQ 070 TQ 090	TQ090	TQ090	TQ 130	TQ 130	TQ 130	TQ 160	TQ 160		0.9
	14	TQ 090	TQ 090	TQ 090	TQ 090 TQ130	TQ130	TQ 130	TQ 130	TQ 130	TQ 160	TQ 160		0.99
BMD 145	16.8	TQ 090	TQ 090	TQ 090	TQ 090 TQ130	TQ130	TQ 160	TQ 160	TQ 160	TQ 160			1.4
	22	TQ 090	TQ 090	TQ 090	TQ 090 TQ130	TQ130	TQ 160	TQ 160	TQ 160				1.76
BMD 170	34	TQ 090 TQ 130	TQ 090 TQ 130	TQ 090 TQ 130	TQ130	TQ 160	TQ 160	TQ 160					2.9
	45	TQ 130	TQ 130	TQ 130	TQ130	TQ 160	TQ 160						4.75

Distribution of gearbox output torque [Nm]

	3	4	5	7	10	16	20	25	40	50	70
TQ 060	21	30	30	25	20	30	30	30	30	30	25
TQ 070	45	70	70	60	40	70	70	70	70	70	60
TQ 090	130	200	180	160	110	200	180	180	200	180	160
TQ 130	260	400	400	360	280	400	400	400	400	400	360
TQ 160	530	800	800	750	550	800	800	800	800	800	750

Notes:

Input speed lower than 3000 min⁻¹.

Safety factor 1 < S ≤ 4.

For any additional technical information about gearboxes selection see relevant catalogues.

Bonfiglioli worldwide presence

Bonfiglioli is located in regions and countries around the world that enable us to provide faster sales and service to customers.
We are around the world, and around the corner.

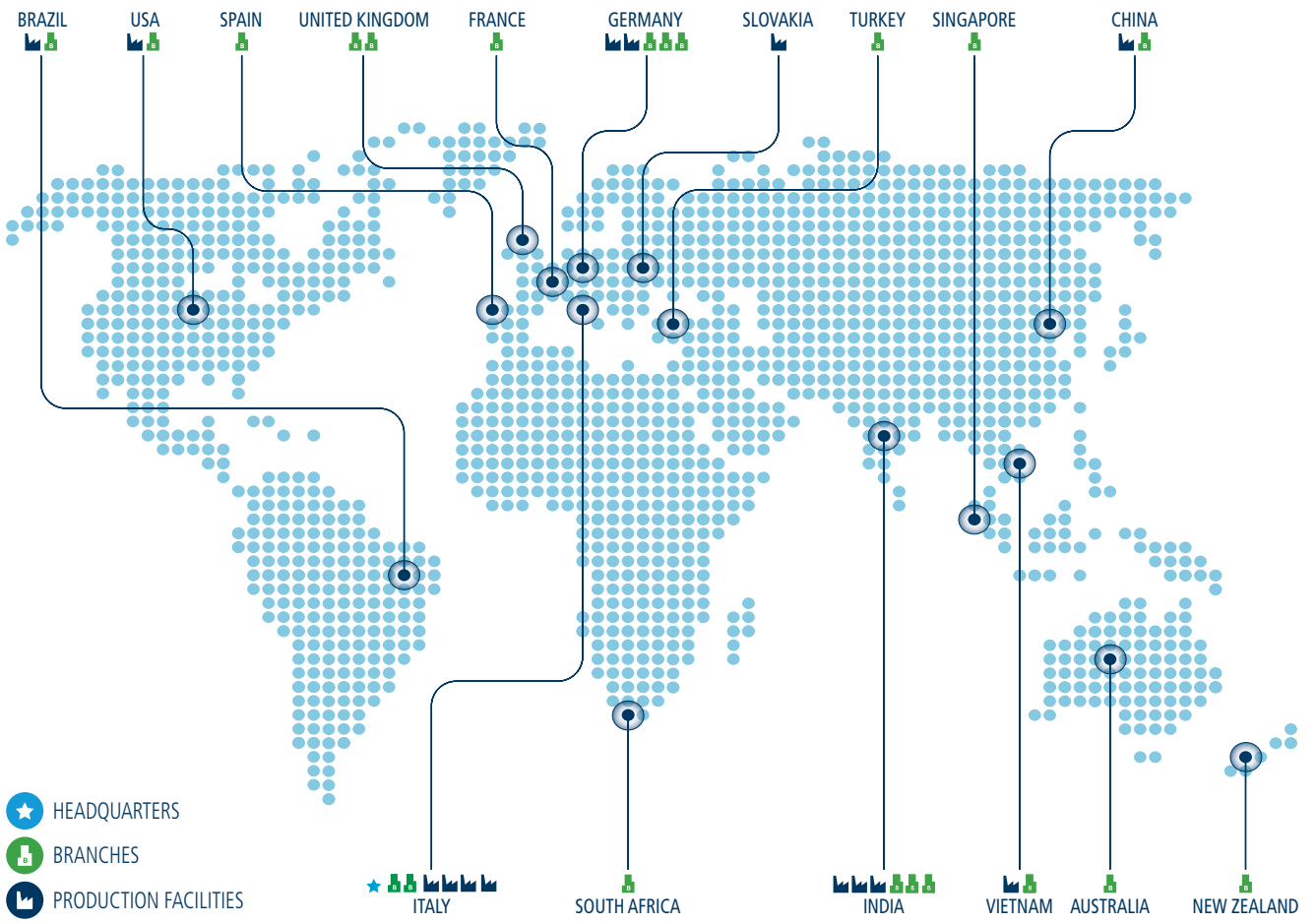

LOCAL SUPPORT
 Sales, Customer Service,
 Warranty, Tech support,
 Spare parts



**21 BRANCH OFFICES
 IN 15 COUNTRIES**



**WORLDWIDE
 DISTRIBUTION
 NETWORK**

Bonfiglioli is your partner worldwide for power transmission and motion control.

Customer satisfaction has always been one of Bonfiglioli's key values. It is pursued around the world, and in a wide range of contexts, by a network of subsidiaries located in 17 countries and on 5 continents.

Each subsidiary provides rapid and efficient pre-sales and after-sales service, and can guarantee prompt deliveries from local assembly plant and warehouses.

In addition to our directly controlled subsidiaries, Bonfiglioli can also rely on an extensive network of authorised dealers, selected for their ability to guarantee excellent pre-sales and after-sales assistance.

To give everybody the chance to purchase a Bonfiglioli product - anywhere.

This is the ambitious objective that drives the development of our added value sales networks, off and on-line.

BEST (Bonfiglioli Excellence Service Team) is one of the most modern sales organisations in the field of power transmission.

Our BEST partners can benefit from our local assembly plant and warehouses, our training courses and tools, and our promotional activities.

For the first time ever, manufacturer and distributors are working together from the product assembly stage and in the design of new applications, in a sharing process that sees one party transferring know-how and technology and the other partly providing a thorough knowledge of the local market.

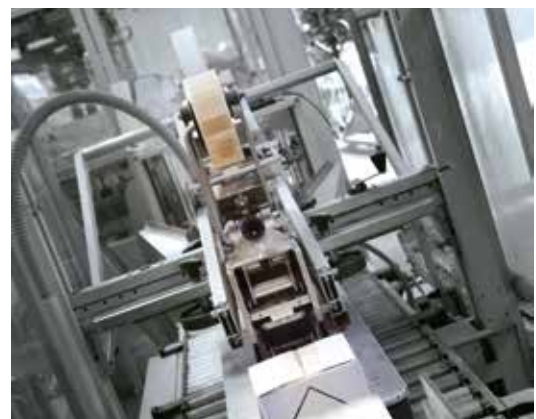
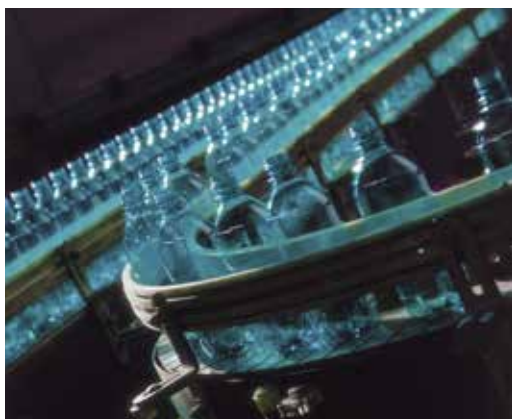

Bonfiglioli worldwide locations

Australia

www.bonfiglioli.com.au
2, Cox Place Glendenning NSW 2761
Locked Bag 1000 Plumpton NSW 2761
Tel. + 61 2 8811 8000

Brazil

www.bonfigliolidobrasil.com.br
Travessa Cláudio Armando 171
Bloco 3 - CEP 09861-730 - Bairro Assunção
São Bernardo do Campo - São Paulo
Tel. +55 11 4344 2322

China

www.bonfiglioli.cn
Bonfiglioli Drives (Shanghai) Co., Ltd.
#68, Hui-Lian Road, QingPu District,
201707 Shanghai
Tel. +86 21 6700 2000

France

www.bonfiglioli.fr
14 Rue Eugène Pottier
Zone Industrielle de Moimont II - 95670 Marly la Ville
Tel. +33 1 34474510

Germany

www.bonfiglioli.de
Sperberweg 12 - 41468 Neuss
Tel. +49 0 2131 2988 0

Industrial

Europark Fichtenhain B6 - 47807 Krefeld
Tel. +49 0 2151 8396 0

O&K Antriebstechnik

Ruhrallee 8-12 - 45525 Hattingen
Tel. +49 0 2324 2050 1

India

www.bonfiglioli.in

Mobile, Wind

Bonfiglioli Transmissions Pvt. Ltd.
Plot No. AC7-AC11, SIDCO Industrial Estate,
Thirumudivakkam - 600 044 Chennai
Tel. +91 44 2478 1035

Industrial

Survey No. 528, Porambakkam High Road,
Mannur Village, Sriperambudur Taluk - 602 105 Chennai
Tel. +91 44 6710 3800
Plot No. A-95, Phase IV, MIDC Chakan, Village Nighoje
Pune, Maharashtra - 410 501

Italy

www.bonfiglioli.it

Headquarters

Bonfiglioli Riduttori S.p.A.
Via Giovanni XXIII, 7/A
Lippo di Calderara di Reno - 40012 Bologna
Tel. +39 051 647 3111

Mobile, Wind

Via Enrico Mattei, 12 Z.I. Villa Selva - 47100 Forlì
Tel. +39 0543 789111

Industrial

Via Bazzane, 33/A - 40012 Calderara di Reno
Tel. +39 051 6473111
Via Trinità, 1 - 41058 Vignola
Tel. +39 059 768511
Via Sandro Pertini lotto 7b - 20080 Carpiano
Tel. +39 02 985081

Bonfiglioli Mechatronic Research

Via F. Zeni 8 - 38068 Rovereto
Tel. +39 0464 443435/36

New Zealand

www.bonfiglioli.co.nz
88 Hastie Avenue, Mangere Bridge, 2022 Auckland
PO Box 11795, Ellerslie
Tel. +64 09 634 6441

Singapore

www.bonfiglioli.com
24 Pioneer Crescent #02-08
West Park Bizcentral - Singapore, 628557
Tel. +65 6268 9869

Slovakia

www.bonfiglioli.com
Robotnícka 2129
Považská Bystrica, 01701 Slovakia
Tel. +421 42 430 75 64

South Africa

www.bonfiglioli.co.za
55 Galaxy Avenue, Linbro Business Park - Sandton
Tel. +27 11 608 2030

Spain

www.tecnotrans.bonfiglioli.com
Tecnotrans Bonfiglioli S.A.
Pol. Ind. Zona Franca, Sector C, Calle F, nº 6
08040 Barcelona
Tel. +34 93 447 84 00

Turkey

www.bonfiglioli.com.tr
Atatürk Organize Sanayi Bölgesi, 10007 Sk. No. 30
Atatürk Organize Sanayi Bölgesi, 35620 Çiğli - Izmir
Tel. +90 0 232 328 22 77

United Kingdom

www.bonfiglioli.co.uk

Industrial

Unit 7, Colemeadow Road
North Moons Moat - Redditch, Worcestershire B98 9PB
Tel. +44 1527 65022

Mobile, Wind

3 - 7 Grosvenor Grange, Woolston
Warrington - Cheshire WA1 4SF
Tel. +44 1925 852667

USA

www.bonfiglioliusa.com
3541 Hargrave Drive
Hebron, Kentucky 41048
Tel. +1 859 334 3333

Vietnam

www.bonfiglioli.vn
Lot C-9D-CN My Phuoc Industrial Park 3
Ben Cat - Binh Duong Province
Tel. +84 650 3577411

BMD Brushless motor photos used inside this catalogue do not represent the real product colour.
The actual colour is black (RAL 9005). Silver dressing has to be intended for marketing and promotional purposes only.



We have a relentless commitment to excellence, innovation and sustainability. Our team creates, distributes and services world-class power transmission and drive solutions to keep the world in motion.



HEADQUARTERS

Bonfiglioli Riduttori S.p.A.
Via Giovanni XXIII, 7/A
40012 Lippo di Calderara di Reno
Bologna (Italy)
tel: +39 051 647 3111
fax: +39 051 647 3126
bonfiglioli@bonfiglioli.com
www.bonfiglioli.com